

# ***fx-300ES PLUS***

*(2nd edition / NATURAL-V.P.A.M.)*

## ***User's Guide***

CASIO Worldwide Education Website

<https://edu.casio.com>

Manuals are available in multi languages at

<https://world.casio.com/manual/calc/>

# Table of Contents

---

<b>Before Using the Calculator</b> .....	<b>4</b>
About this Manual.....	4
Initializing the Calculator.....	4
Precautions.....	4
Safety Precautions.....	4
Handling Precautions.....	5
Getting Started.....	5
Removing the Hard Case.....	5
Turning Power On and Off.....	6
Adjusting Display Contrast.....	6
Key Markings.....	6
Reading the Display.....	7
Using Menus.....	9
<b>Calculation Modes and Calculator Setup</b> .....	<b>10</b>
Calculation Mode.....	10
Configuring the Calculator Setup.....	10
Initializing Calculator Settings.....	14
<b>Inputting Expressions and Values</b> .....	<b>16</b>
Basic Input Rules.....	16
Inputting with Natural Display.....	17
$\sqrt{\quad}$ Form Calculation Range.....	17
Using Values and Expressions as Arguments (Natural Display only)....	18
Overwrite Input Mode (Linear Display only).....	19
Correcting and Clearing an Expression.....	19
<b>Basic Calculations</b> .....	<b>20</b>
Toggling Calculation Results.....	20
Fraction Calculations.....	21
Percent Calculations.....	22
Degree, Minute, Second (Sexagesimal) Calculations.....	22
Multi-Statements.....	23
Using Engineering Notation.....	23
Remainder Calculations.....	24
Recurring Decimal Calculations.....	25
Prime Factorization.....	29
Calculation History and Replay.....	30
Calculation History.....	30
Replay.....	31
Using Memory Functions.....	31
Answer Memory (Ans)/Previous Answer Memory (PreAns).....	31
Variables (A, B, C, D, E, F, M, X, Y).....	33

Independent Memory (M).....	33
Clearing the Contents of All Memories.....	34
<b>Function Calculations.....</b>	<b>35</b>
Pi ( $\pi$ ), Natural Logarithm Base $e$ .....	35
Trigonometric Functions.....	35
Hyperbolic Functions.....	35
Angle Unit Conversion.....	36
Exponential Functions.....	36
Logarithmic Functions.....	36
Power Functions and Power Root Functions.....	37
Rectangular-Polar Coordinate Conversion.....	38
Factorial Function (!).....	39
Absolute Value Function (Abs).....	39
Random Number (Ran#).....	40
Random Integer (RanInt#).....	40
Permutation ( $nPr$ ) and Combination ( $nCr$ ).....	40
Rounding Function (Rnd).....	41
Greatest Common Divisor (GCD) and Least Common Multiple (LCM).....	41
Integer Part of a Value (Int) and Largest Integer that does not Exceed a Value (Intg).....	42
<b>Using Calculation Modes.....</b>	<b>43</b>
Statistical Calculations (STAT).....	43
Inputting Data.....	44
Statistics Calculation Screen.....	45
Using the Statistics Menu.....	45
Calculating Estimated Values.....	50
Creating a Numerical Table from Two Functions (TABLE).....	51
<b>Technical Information.....</b>	<b>54</b>
Errors.....	54
Displaying the Location of an Error.....	54
Clearing the Error Message.....	54
Error Messages.....	54
Before Assuming Malfunction of the Calculator... ..	56
Replacing the Battery.....	56
Calculation Priority Sequence.....	57
Calculation Ranges, Number of Digits, and Precision.....	58
Calculation Range and Precision.....	58
Function Calculation Input Ranges and Precision.....	58
Specifications.....	61
Verifying the Authenticity of Your Calculator.....	61

<b>Frequently Asked Questions.....</b>	<b>62</b>
Frequently Asked Questions.....	62

# Before Using the Calculator

---

## About this Manual

---

- In no event shall CASIO Computer Co., Ltd. be liable to anyone for special, collateral, incidental, or consequential damages in connection with or arising out of the purchase or use of this product and items that come with it.
- Moreover, CASIO Computer Co., Ltd. shall not be liable for any claim of any kind whatsoever by any other party arising out of the use of this product and the items that come with it.
- Unless specifically stated, all sample operations in this manual assume that the calculator is in its initial default setup. Use the procedure under "Initializing the Calculator" to return the calculator to its initial default setup.
- The contents of this manual are subject to change without notice.
- The displays and illustrations (such as key markings) shown in this manual are for illustrative purposes only, and may differ somewhat from the actual items they represent.
- QR Code is a registered trademark of DENSO WAVE INCORPORATED in Japan and in other countries.
- Company and product names used in this manual may be registered trademarks or trademarks of their respective owners.

## Initializing the Calculator

---

Perform the following procedure when you want to initialize the calculator and return the calculation mode and setup to their initial default settings.

Note that this operation also clears all data currently in calculator memory.

**SHIFT** **9** (CLR) **3** (All) **☐** (Yes)

## Precautions

---

Be sure to read the following safety precautions before using the calculator.

### **Safety Precautions**

#### **⚠ Battery**

- Keep batteries out of the reach of small children.

- Use only the type of battery specified for this calculator in this manual.

## Handling Precautions

- Even if the calculator is operating normally, replace the battery according to the schedule shown below. Continued use after the specified number of years may result in abnormal operation. Replace the battery immediately after display figures become dim.  
fx-300ES PLUS: Every 3 years
- A dead battery can leak, causing damage to and malfunction of the calculator. Never leave a dead battery in the calculator.
- **The battery that comes with the calculator is for factory testing, and it discharges slightly during shipment and storage. Because of these reasons, its battery life may be shorter than normal.**
- Do not use a nickel-based primary battery with this product. Incompatibility between such batteries and product specifications can result in shorter battery life and product malfunction.
- Avoid use and storage of the calculator in areas subjected to temperature extremes, and large amounts of humidity and dust.
- Do not subject the calculator to excessive impact, pressure, or bending.
- Never try to take the calculator apart.
- Use a soft, dry cloth to clean the exterior of the calculator.
- Whenever discarding the calculator or batteries, be sure to do so in accordance with the laws and regulations in your particular area.

## Getting Started

---

### Removing the Hard Case

Before using the calculator, slide its hard case downwards to remove it, and then affix the hard case to the back of the calculator as shown in the illustration below.

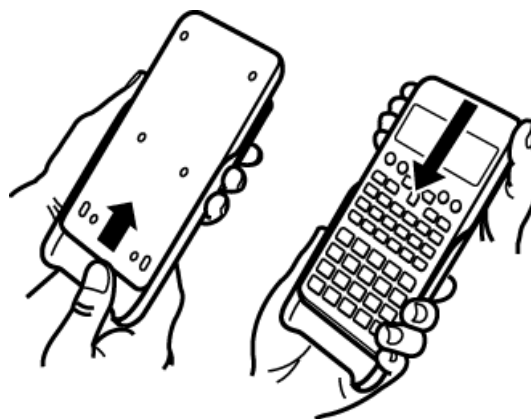

## Turning Power On and Off

- Press **[ON]** to turn on the calculator.
- Press **[SHIFT]** **[AC]** (OFF) to turn off the calculator.

### Note

- The calculator also will turn off automatically after approximately 10 minutes of non-use. Press the **[ON]** key to turn the calculator back on.

## Adjusting Display Contrast

1. Press **[SHIFT]** **[MODE]** (SETUP) **[7]** (**[◀CONT▶]**).



2. Use **[◀]** and **[▶]** to adjust display contrast.
3. After the setting is the way you want, press **[AC]**.

### Important!

- If adjusting display contrast does not improve display readability, it probably means that battery power is low. Replace the battery.

## Key Markings

Pressing the **[SHIFT]** or **[ALPHA]** key followed by a second key performs the alternate function of the second key. The alternate function is indicated by the text printed above the key.



(1) Keycap function (2) Alternate function

- The following shows an example of how an alternate function operation is represented in this manual.

Example: **[SHIFT]** **[sin]** ( $\sin^{-1}$ ) \* 1 **[=]**

- \* Indicates the function that is accessed by the key operation (**[SHIFT]** **[sin]**) before it. Note that this is not part of the actual key operation you perform.

- The following shows an example of how a key operation to select an on-screen menu item is represented in this manual.

Example:  $\boxed{1}$ (COMP)\*

\* Indicates the menu item that is selected by the number key operation ( $\boxed{1}$ ) before it. Note that this is not part of the actual key operation you perform.

- The cursor key is marked with four arrows, indicating direction, as shown in the illustration nearby. In this manual, cursor key operation is indicated as  $\blacktriangle$ ,  $\blacktriangledown$ ,  $\blacktriangleleft$ , and  $\blacktriangleright$ .



## Reading the Display

The two-line display makes it possible to view both the input expression and its result at the same time.

(1)	Pol( $\sqrt{2}, \sqrt{2}$ )	Pol(1.414213562▶)	(3)
(2)	r=2, $\theta=45$	r=2, $\theta=0.7853981▶$	

- (1) Input expression
- (2) Calculation result
- (3) Indicators

- If a  $\blacktriangleright$  indicator appears on the right side of the calculation result, it means the displayed calculation result continues to the right. Use  $\blacktriangleright$  and  $\blacktriangleleft$  to scroll the calculation result display.
- If a  $\blacktriangleright$  indicator appears on the right side of the input expression, it means the displayed calculation continues to the right. Use  $\blacktriangleright$  and  $\blacktriangleleft$  to scroll the input expression display. Note that if you want to scroll the input expression while both the  $\blacktriangleright$  and  $\blacktriangleright$  indicators are displayed, you will need to press  $\boxed{AC}$  first and then use  $\blacktriangleright$  and  $\blacktriangleleft$  to scroll.

### Display indicators

This indicator:	Means this:
<b>S</b>	The keypad has been shifted by pressing the $\boxed{SHIFT}$ key. The keypad will unshift and this indicator will disappear when you press a key.



<b>A</b>	The alpha input mode has been entered by pressing the <b>ALPHA</b> key. The alpha input mode will be exited and this indicator will disappear when you press a key.
<b>M</b>	There is a value stored in independent memory.
<b>STO</b>	The calculator is standing by for input of a variable name to assign a value to the variable. This indicator appears after you press <b>SHIFT</b> <b>RCL</b> (STO).
<b>RCL</b>	The calculator is standing by for input of a variable name to recall the variable's value. This indicator appears after you press <b>RCL</b> .
<b>STAT</b>	The calculator is in the STAT Mode.
<b>D</b>	The default angle unit is degrees.
<b>R</b>	The default angle unit is radians.
<b>G</b>	The default angle unit is grads.
<b>FIX</b>	A fixed number of decimal places is in effect.
<b>SCI</b>	A fixed number of significant digits is in effect.
<b>Math</b>	Natural Display is selected as the display format.
<b>▼▲</b>	Calculation history memory data is available and can be replayed, or there is more data above/ below the current screen.
<b>Disp</b>	The display currently shows an intermediate result of a multi-statement calculation.

### Important!

- For some type of calculation that takes a long time to execute, the display may show only the above indicators (without any value) while it performs the calculation internally.

## Using Menus

Some of the calculator's operations are performed using menus. Pressing **MODE** or **hyp**, for example, will display a menu of applicable functions. The following are the operations you should use to navigate between menus.

- You can select a menu item by pressing the number key that corresponds to the number to its left on the menu screen.
- The ▼ indicator in the upper right corner of a menu means there is another menu below the current one. The ▲ indicator means another menu above. Use ▼ and ▲ to switch between menus.
- To close a menu without selecting anything, press **AC**.

# Calculation Modes and Calculator Setup

## Calculation Mode

Before starting a calculation, you must first enter the correct mode as indicated in the table below.

When you want to perform this type of operation:	Perform this key operation:
General calculations	<b>MODE</b> <b>1</b> (COMP)
Statistical and regression calculations	<b>MODE</b> <b>2</b> (STAT)
Generation of a numerical table based on one or two functions	<b>MODE</b> <b>3</b> (TABLE)

### Note

- The initial default calculation mode is the COMP Mode.

## Configuring the Calculator Setup

Pressing **SHIFT** **MODE** (SETUP) displays the setup menu, which you can use to control how the calculations are executed and displayed. The setup menu has two screens, which you can jump between using **▼** and **▲**.

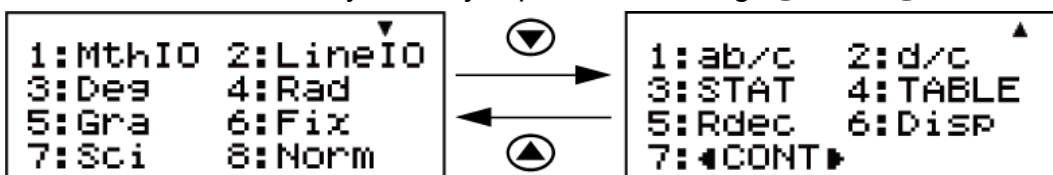

Underlined (     ) settings are initial defaults.

### Specifying the Display Format

To specify this display format:	Perform this key operation:
Natural Display (MthIO-MathO)	<b>SHIFT</b> <b>MODE</b> (SETUP) <u><b>1</b></u> (MthIO) <u><b>1</b></u> (MathO)

<b>Natural Display (MthIO-LineO)</b>	<b>SHIFT</b> <b>MODE</b> (SETUP) <b>1</b> (MthIO) <b>2</b> (LineO)
<b>Linear Display (LineIO)</b>	<b>SHIFT</b> <b>MODE</b> (SETUP) <b>2</b> (LineIO)

Natural Display (MthIO-MathO, MthIO-LineO) causes fractions, irrational numbers, and other expressions to be displayed as they are written on paper.

MthIO-MathO displays input and calculation results using the same format as they are written on paper.

MthIO-LineO displays input the same way as MthIO-MathO, but calculation results are displayed in linear format.

Linear Display (LineIO) causes fractions and other expressions to be displayed in a single line.

Examples:

MthIO-MathO

$$1 \div 200$$

$$\frac{1}{200}$$

MthIO-LineO  
(Number Format: Norm 1)

$$1 \div 200$$

$$5 \times 10^{-3}$$

MthIO-LineO  
(Number Format: Norm 2)

$$1 \div 200$$

$$0.005$$

LineIO  
(Number Format: Norm 1)

$$1 \div 200$$

$$5 \times 10^{-3}$$

### Note

- The calculator switches to Linear Display automatically whenever you enter the STAT Mode.

### Specifying the Default Angle Unit

To specify this as the default angle unit:	Perform this key operation:
Degrees	<b>SHIFT</b> <b>MODE</b> (SETUP) <b>3</b> (Deg)
Radians	<b>SHIFT</b> <b>MODE</b> (SETUP) <b>4</b> (Rad)
Grads	<b>SHIFT</b> <b>MODE</b> (SETUP) <b>5</b> (Gra)

$$90^\circ = \pi/2 \text{ radians} = 100 \text{ grads}$$

### Specifying the Number Format

Specifies the number of digits for display of a calculation result.

To specify this:	Perform this key operation:
Number of Decimal Places	<b>SHIFT</b> <b>MODE</b> (SETUP) <b>6</b> (Fix) <b>0</b> - <b>9</b>
Number of Significant Digits	<b>SHIFT</b> <b>MODE</b> (SETUP) <b>7</b> (Sci) <b>0</b> - <b>9</b>
Exponential Display Range	<b>SHIFT</b> <b>MODE</b> (SETUP) <b>8</b> (Norm) <b>1</b> (Norm 1) or <b>2</b> (Norm 2)

**Fix:** The value you specify (from 0 to 9) controls the number of decimal places for displayed calculation results. Calculation results are rounded off to the specified digit before being displayed.

Example: (LineIO)  $100 \div 7 = 14.286$  (Fix 3)  
 $14.29$  (Fix 2)

**Sci:** The value you specify (from 0 to 9) controls the number of significant digits for displayed calculation results. Calculation results are rounded off to the specified digit before being displayed.

Example: (LineIO)  $1 \div 7 = 1.4286 \times 10^{-1}$  (Sci 5)  
 $1.429 \times 10^{-1}$  (Sci 4)  
 $1.428571429 \times 10^{-1}$  (Sci 0)

**Norm:** Selecting one of the two available settings (Norm 1, Norm 2) determines the range in which results will be displayed in exponential

format. Outside the specified range, results are displayed using non-exponential format.

Norm 1:  $10^{-2} > |x|$ ,  $|x| \geq 10^{10}$

Norm 2:  $10^{-9} > |x|$ ,  $|x| \geq 10^{10}$

Example: (LineIO)  $1 \div 200 = 5 \times 10^{-3}$  (Norm 1)  
0.005 (Norm 2)

### Specifying the Fraction Display Format

To specify this fraction display format:	Perform this key operation:
Mixed	<b>SHIFT</b> <b>MODE</b> (SETUP) $\blacktriangledown$ <b>1</b> (ab/c)
Improper	<b>SHIFT</b> <b>MODE</b> (SETUP) $\blacktriangledown$ <b>2</b> (d/c)

### Specifying the Stat Format

Specifies whether or not to display a FREQ (frequency) column in the STAT Mode Statistics Editor.

To specify this:	Perform this key operation:
Show FREQ Column	<b>SHIFT</b> <b>MODE</b> (SETUP) $\blacktriangledown$ <b>3</b> (STAT) <b>1</b> (ON)
Hide FREQ Column	<b>SHIFT</b> <b>MODE</b> (SETUP) $\blacktriangledown$ <b>3</b> (STAT) <b>2</b> (OFF)

### Specifying the Table Format

Specifies whether to use function  $f(x)$  only or the two functions  $f(x)$  and  $g(x)$  in the TABLE Mode.

To specify this:	Perform this key operation:
$f(x)$ only	<b>SHIFT</b> <b>MODE</b> (SETUP) $\blacktriangledown$ <b>4</b> (TABLE) <b>1</b> ( $f(x)$ )
$f(x)$ and $g(x)$	<b>SHIFT</b> <b>MODE</b> (SETUP) $\blacktriangledown$ <b>4</b> (TABLE) <b>2</b> ( $f(x),g(x)$ )

### Specifying the Recurring Decimal Format

Specifies whether or not to display calculation results using recurring decimal form.

To specify this:	Perform this key operation:
Use recurring decimal form	<b>SHIFT</b> <b>MODE</b> (SETUP) <b>▼</b> <b>5</b> (Rdec) <b>1</b> (ON)
Do not use recurring decimal form	<b>SHIFT</b> <b>MODE</b> (SETUP) <b>▼</b> <b>5</b> (Rdec) <b>2</b> (OFF)

### Specifying the Decimal Point Display Format

Specifies whether to display a dot or a comma for the calculation result decimal point. A dot is always displayed during input.

To specify this decimal point display format:	Perform this key operation:
Dot (.)	<b>SHIFT</b> <b>MODE</b> (SETUP) <b>▼</b> <b>6</b> (Disp) <b>1</b> (Dot)
Comma (,)	<b>SHIFT</b> <b>MODE</b> (SETUP) <b>▼</b> <b>6</b> (Disp) <b>2</b> (Comma)

#### Note

- When dot is selected as the decimal point, the separator for multiple results is a comma (,). When comma is selected, the separator is a semicolon (;).

### Adjusting Display Contrast

**SHIFT** **MODE** (SETUP) **▼** **7** (◀CONT▶)

See "Getting Started" for details.

## Initializing Calculator Settings

Perform the following procedure to initialize the calculator, which returns the calculation mode to COMP and returns all other settings, including setup menu settings, to their initial defaults.

**SHIFT** **9** (CLR) **1** (Setup) **≡** (Yes)

This setting:	Is initialized to this:
Calculation Mode	COMP
Display Format	MthIO-MathO
Angle Unit	Deg

Number Format	Norm 1
Fraction Display Format	d/c
Stat Format	OFF
Table Format	$f(x),g(x)$
Recurring Decimal Format	ON
Decimal Point	Dot



# Inputting Expressions and Values

## Basic Input Rules

Calculations can be input in the same form as they are written. When you press  $\text{=}$  the priority sequence of the input calculation will be evaluated automatically and the result will appear on the display.

**Example 1:**  $4 \times \sin 30 \times (30 + 10 \times 3) = 120$

4 [x] [sin] 30 [)] [x] ([ 30 + 10 [x] 3 [)] [=]

\*1 Input of the closing parenthesis is required for sin, sinh, and other functions that include parentheses.

\*2 These multiplication symbols (x) can be omitted. A multiplication symbol can be omitted when it occurs immediately before an opening parenthesis, immediately before sin or other function that includes parentheses, immediately before the Ran# (random number) function, or immediately before a variable (A, B, C, D, E, F, M, X, Y), scientific constants,  $\pi$  or  $e$ .

\*3 The closing parenthesis immediately before the [=] operation can be omitted.

Calculator display:  $4 \times \sin(30) \times (30 + 10 \times 3) = 120$

- \*1 Input of the closing parenthesis is required for sin, sinh, and other functions that include parentheses.
- \*2 These multiplication symbols (x) can be omitted. A multiplication symbol can be omitted when it occurs immediately before an opening parenthesis, immediately before sin or other function that includes parentheses, immediately before the Ran# (random number) function, or immediately before a variable (A, B, C, D, E, F, M, X, Y), scientific constants,  $\pi$  or  $e$ .
- \*3 The closing parenthesis immediately before the [=] operation can be omitted.

**Example 2:** Input example omitting [x]<sup>\*2</sup> and [)]<sup>\*3</sup> operations in the above example.

4 [sin] 30 [)] ([ 30 + 10 [x] 3 [=]

Calculator display:  $4 \sin(30) (30 + 10 \times 3) = 120$

### Note

- If the calculation becomes longer than the screen width during input, the screen will scroll automatically to the right and the  $\blacktriangleleft$  indicator will appear on the display. When this happens, you can scroll back to the left by using  $\blacktriangleleft$  and  $\blacktriangleright$  to move the cursor.
- When Linear Display is selected, pressing  $\blacktriangleup$  will cause the cursor to jump to the beginning of the calculation, while  $\blacktriangledown$  will jump to the end.

- When Natural Display is selected, pressing  $\blacktriangleright$  while the cursor is at the end of the input calculation will cause it to jump to the beginning, while pressing  $\blacktriangleleft$  while the cursor is at the beginning will cause it to jump to the end.
- You can input up to 99 bytes for a calculation. Each numeral, symbol, or function normally uses one byte. Some functions require three to 13 bytes.
- The cursor will change shape to  $\blacksquare$  when there are 10 bytes or less of allowed input remaining. If this happens, end calculation input and then press  $\boxed{=}$ .

## Inputting with Natural Display

Selecting Natural Display makes it possible to input and display fractions and certain functions ( $\log$ ,  $x^2$ ,  $x^3$ ,  $x^{\blacksquare}$ ,  $\sqrt{\blacksquare}$ ,  $\sqrt[3]{\blacksquare}$ ,  $\sqrt[\blacksquare]{\blacksquare}$ ,  $x^{-1}$ ,  $10^{\blacksquare}$ ,  $e^{\blacksquare}$ , Abs) just as they are written in your textbook.

**Example:**  $\frac{2 + \sqrt{2}}{1 + \sqrt{2}}$  (MthIO-MathO)



### Important!

- Certain types of expressions can cause the height of an input expression to be greater than one display line. The maximum allowable height of an input expression is two display screens (31 dots  $\times$  2). Further input will become impossible if the height of the calculation you are inputting exceeds the allowable limit.
- Nesting of functions and parentheses is allowed. Further input will become impossible if you nest too many functions and/or parentheses. If this happens, divide the calculation into multiple parts and calculate each part separately.

### Note

- When you press  $\boxed{=}$  and obtain a calculation result using Natural Display, part of the expression you input may be cut off. If you need to view the entire input expression again, press  $\boxed{AC}$  and then use  $\blacktriangleleft$  and  $\blacktriangleright$  to scroll the input expression.

## $\sqrt{\quad}$ Form Calculation Range

Results that include square root symbols can have up to two terms (an integer term is also counted as a term).

When a calculation result takes the form  $\pm \frac{a\sqrt{b}}{c} \pm \frac{d\sqrt{e}}{f}$ ,  $\sqrt{\quad}$  form calculation results are displayed using formats like those shown below.

$$\pm a\sqrt{b}, \pm d \pm a\sqrt{b}, \frac{\pm a'\sqrt{b} \pm d'\sqrt{e}}{c'}$$

\* The ranges of the coefficients ( $a, b, c, d, e, f$ ) are as shown below.

$$1 \leq a < 100, 1 < b < 1000, 1 \leq c < 100$$

$$0 \leq d < 100, 0 \leq e < 1000, 1 \leq f < 100$$

( $a, b, c, d, e, f$  are integers)

**Example:**

$10\sqrt{2} + 15 \times 3\sqrt{3} = 45\sqrt{3} + 10\sqrt{2}$	$\sqrt{\quad}$ form
$99\sqrt{999} = 3129.089165 (= 297\sqrt{111})$	decimal form

## Using Values and Expressions as Arguments (Natural Display only)

A value or an expression that you have already input can be used as the argument of a function. After you have input  $\frac{7}{6}$ , for example, you can make it the argument of  $\sqrt{\quad}$ , resulting in  $\sqrt{\frac{7}{6}}$ .

**Example:** To input  $1 + \frac{7}{6}$  and then change it to  $1 + \sqrt{\frac{7}{6}}$  (MthIO-MathO)

1  $\boxed{+}$  7  $\boxed{/}$  6  $\boxed{=}$   $1 + \frac{7}{6}$  Math

$\boxed{\leftarrow}$   $\boxed{\leftarrow}$   $\boxed{\leftarrow}$   $\boxed{\leftarrow}$   $\boxed{\text{SHIFT DEL (INS)}}$   $1 + \frac{7}{6}$  Math

$\boxed{\sqrt{\quad}}$   $1 + \sqrt{\frac{7}{6}}$  Math

As shown above, the value or expression to the right of the cursor after  $\boxed{\text{SHIFT DEL (INS)}}$  are pressed becomes the argument of the function that is specified next. The range encompassed as the argument is everything up to the first open parenthesis to the right, if there is one, or everything up to the first function to the right ( $\sin(30)$ ,  $\log_2(4)$ , etc.)

This capability can be used with the following functions:  $\boxed{\frac{\square}{\square}}$ ,  $\boxed{\text{SHIFT}} \boxed{\frac{\square}{\square}}$ ,  $\boxed{\log_{\square}} \boxed{\square}$ ,  $\boxed{\text{ALPHA}} \boxed{\sqrt{\square}} \boxed{\square}$ ,  $\boxed{\text{SHIFT}} \boxed{x^{\square}} \boxed{\square}$ ,  $\boxed{\text{SHIFT}} \boxed{\log} \boxed{(10^{\square})}$ ,  $\boxed{\text{SHIFT}} \boxed{\ln} \boxed{(e^{\square})}$ ,  $\boxed{\sqrt{\square}}$ ,  $\boxed{x^{\square}}$ ,  $\boxed{\text{SHIFT}} \boxed{\sqrt{\square}} \boxed{(3\sqrt{\square})}$ ,  $\boxed{\text{Abs}}$ .

# Overwrite Input Mode (Linear Display only)

---

You can select either insert or overwrite as the input mode, but only while Linear Display is selected. In the overwrite mode, text you input replaces the text at the current cursor location. You can toggle between the insert and overwrite modes by performing the operations: **SHIFT** **DEL** (INS). The cursor appears as "I" in the insert mode and as " \_ " in the overwrite mode.

## Note

- Natural Display always uses the insert mode, so changing display format from Linear Display to Natural Display will automatically switch to the insert mode.

# Correcting and Clearing an Expression

---

## To delete a single character or function:

Move the cursor so it is directly to the right of the character or function you want to delete, and then press **DEL**.

In the overwrite mode, move the cursor so it is directly under the character or function you want to delete, and then press **DEL**.

## To insert a character or function into a calculation:

Use **◀** and **▶** to move the cursor to the location where you want to insert the character or function and then input it. Be sure always to use the insert mode if Linear Display is selected.

## To clear all of the calculation you are inputting:

Press **AC**.

# Basic Calculations

Use the **MODE** key to enter the COMP Mode when you want to perform basic calculations.

**MODE** **1** (COMP)

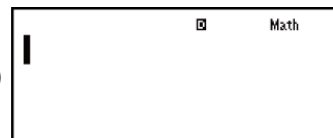

## Toggling Calculation Results

While Natural Display is selected, each press of **S+D** will toggle the currently displayed calculation result between its fraction form and decimal form, its  $\sqrt{\quad}$  form and decimal form, or its  $\pi$  form and decimal form.

**Example 1:**  $\pi \div 6 = \frac{1}{6} \pi = 0.5235987756$  (MthIO-MathO)

**SHIFT** **x10<sup>9</sup>** ( **$\pi$** )  **$\div$**  **6** **=**  $\frac{1}{6} \pi$  **S+D**  $\leftrightarrow$  0.5235987756

**Example 2:**  $(\sqrt{2} + 2) \times \sqrt{3} = \sqrt{6} + 2\sqrt{3} = 5.913591358$  (MthIO-MathO)

**(**  **$\sqrt{\square}$**  **2** **)** **+** **2** **)**  **$\times$**   **$\sqrt{\square}$**  **3** **=**  $\sqrt{6} + 2\sqrt{3}$  **S+D**  $\leftrightarrow$  5.913591358

While Linear Display is selected, each press of **S+D** will toggle the currently displayed calculation result between its decimal form and fraction form.

**Example 3:**  $1 \div 5 = 0.2 = \frac{1}{5}$  (LineIO)

**1**  **$\div$**  **5** **=** 0.2 **S+D**  $\leftrightarrow$  **1**  **$\div$**  **5**

**Example 4:**  $1 - \frac{4}{5} = \frac{1}{5} = 0.2$  (LineIO)

**1**  **$-$**  **4**  **$\div$**  **5** **=** **1**  **$\div$**  **5** **S+D**  $\leftrightarrow$  0.2

## Important!

- Depending on the type of calculation result that is on the display when you press the  $\boxed{\text{S}\oplus\text{D}}$  key, the conversion process may take some time to perform.
- With certain calculation results, pressing the  $\boxed{\text{S}\oplus\text{D}}$  key will not convert the displayed value.
- When ON is selected for Rdec on the setup menu, pressing  $\boxed{\text{S}\oplus\text{D}}$  will switch the calculation result to recurring decimal form. For details, see "Recurring Decimal Calculations".
- You cannot switch from decimal form to mixed fraction form if the total number of digits used in the mixed fraction (including integer, numerator, denominator, and separator symbols) is greater than 10.

## Note

- With Natural Display (MathO), inputting one of the following calculations and then pressing  $\boxed{\text{SHIFT}} \boxed{\text{=}}$  instead of  $\boxed{\text{=}}$  will display the calculation result in decimal form: a calculation that results in a  $\sqrt{\quad}$  form or  $\pi$  form expression, a division calculation. Pressing  $\boxed{\text{S}\oplus\text{D}}$  after that will switch to the fraction form or  $\pi$  form of the calculation result. The  $\sqrt{\quad}$  form of the result will not appear in this case.

# Fraction Calculations

Note that the input method for fractions is different, depending upon whether you are using Natural Display or Linear Display.

**Example 1:**  $\frac{2}{3} + \frac{1}{2} = \frac{7}{6}$

(MthIO-MathO)	$2 \boxed{\text{=}} 3 \boxed{\text{▶}} \boxed{+} 1 \boxed{\text{=}} 2 \boxed{\text{=}}$	$\frac{7}{6}$
or	$\boxed{\text{=}} 2 \boxed{\text{▼}} 3 \boxed{\text{▶}} \boxed{+} \boxed{\text{=}} 1 \boxed{\text{▼}} 2 \boxed{\text{=}}$	$\frac{7}{6}$
(LineIO)	$2 \boxed{\text{=}} 3 \boxed{+} 1 \boxed{\text{=}} 2 \boxed{\text{=}}$	$7 \blacktriangleleft 6$

**Example 2:**  $4 - 3\frac{1}{2} = \frac{1}{2}$

(MthIO-MathO)	$4 \boxed{-} \boxed{\text{SHIFT}} \boxed{\text{=}} (\boxed{\text{=}}) 3 \boxed{\text{▶}} 1 \boxed{\text{▼}} 2 \boxed{\text{=}}$	$\frac{1}{2}$
(LineIO)	$4 \boxed{-} 3 \boxed{\text{=}} 1 \boxed{\text{=}} 2 \boxed{\text{=}}$	$1 \blacktriangleleft 2$

## Note

- Mixing fractions and decimal values in a calculation while Linear Display is selected will cause the result to be displayed as a decimal value.
- Results of calculations that mix fraction and decimal values are always decimal.
- Fractions in calculation results are displayed after being reduced to their lowest terms.

**To switch a calculation result between improper fraction and mixed fraction form:**

Perform the following key operation:  $\boxed{\text{SHIFT}} \boxed{\text{S}\leftrightarrow\text{D}} \left(a\frac{b}{c} + \frac{d}{c}\right)$

**To switch a calculation result between fraction and decimal form:**

Press  $\boxed{\text{S}\leftrightarrow\text{D}}$ .

## Percent Calculations

---

Inputting a value and pressing  $\boxed{\text{SHIFT}} \boxed{\text{C}} (\%)$  causes the input value to become a percent.

**Example 1:**  $150 \times 20\% = 30$

$$150 \boxed{\times} 20 \boxed{\text{SHIFT}} \boxed{\text{C}} (\%) \boxed{=}$$
 30

**Example 2:** Calculate what percentage of 880 is 660 (75%)

$$660 \boxed{\div} 880 \boxed{\text{SHIFT}} \boxed{\text{C}} (\%) \boxed{=}$$
 75

**Example 3:** Increase 2500 by 15% (2875)

$$2500 \boxed{+} 2500 \boxed{\times} 15 \boxed{\text{SHIFT}} \boxed{\text{C}} (\%) \boxed{=}$$
 2875

**Example 4:** Decrease 3500 by 25% (2625)

$$3500 \boxed{-} 3500 \boxed{\times} 25 \boxed{\text{SHIFT}} \boxed{\text{C}} (\%) \boxed{=}$$
 2625

## Degree, Minute, Second (Sexagesimal) Calculations

---

You can perform calculations using sexagesimal values, and convert values between sexagesimal and decimal.

Performing an addition or subtraction operation between sexagesimal values, or a multiplication or division operation between a sexagesimal value and a decimal value will cause the result to be displayed as a sexagesimal value.

You also can convert between sexagesimal and decimal.

The following is the input format for a sexagesimal value: {degrees} {minutes} {seconds}.

### Note

- You must always input something for the degrees and minutes, even if they are zero.

**Example 1:**  $2^{\circ}20'30'' + 39'30'' = 3^{\circ}00'00''$

2 20 30 + 0 39 30 =  $3^{\circ}0'0''$

**Example 2:** Convert  $2^{\circ}15'18''$  to its decimal equivalent.

2 15 18 =  $2^{\circ}15'18''$

(Converts sexagesimal to decimal.) = 2.255

(Converts decimal to sexagesimal.) =  $2^{\circ}15'18''$

## Multi-Statements

You can use the colon character (:) to connect two or more expressions and execute them in sequence from left to right when you press =.

**Example:**  $3 + 3 : 3 \times 3$

3 + 3 ALPHA x<sup>3</sup> (: ) 3 x 3 = 6  
= 9

## Using Engineering Notation

A simple key operation transforms a displayed value to engineering notation.

**Example 1:** Transform the value 1234 to engineering notation, shifting the decimal point to the right.

1234 = 1234  
ENG 1.234×10<sup>3</sup>  
ENG 1234×10<sup>0</sup>

**Example 2:** Transform the value 123 to engineering notation, shifting the decimal point to the left.



123  $\square$

123

$\square$   $\square$  ( $\leftarrow$ )

$0.123 \times 10^3$

$\square$   $\square$  ( $\leftarrow$ )

$0.000123 \times 10^6$

## Remainder Calculations

You can use the  $\div R$  function to obtain the quotient and remainder in a division calculation.

**Example:** To calculate the quotient and remainder of  $5 \div 2$  (quotient = 2, remainder = 1)

(MthIO-MathO)

5  $\square$   $\square$  ( $\div R$ ) 2  $\square$

5 $\div$ R2  
2,R=1

(LineIO)

5  $\square$   $\square$  ( $\div R$ ) 2  $\square$

5 $\div$ R2  
R= 2  
1

### Note

- Only the quotient value of a  $\div R$  calculation is stored in Ans memory.
- Assigning the result of a remainder division calculation to a variable will assign the quotient value only. Performing the operation 5  $\square$   $\square$  ( $\div R$ ) 2  $\square$   $\square$  ( $\square$ ) ( $\square$ ) (X) (which assigns the result of  $5 \div R2$  to X) will assign a value of 2 to X.
- If a  $\div R$  calculation is part of a multi-step calculation, only the quotient is passed on to the next operation.

Example: 10  $\square$   $\square$  17  $\square$   $\square$  ( $\div R$ ) 6  $\square$   $\square$   $\rightarrow$  10  $\square$   $\square$  2  $\square$   $\square$   $\rightarrow$  12

- Operation of the  $\square$  and  $\square$  keys is disabled while a remainder division result is on the display.

### Cases when Remainder Division becomes Non-remainder Division

If either of the conditions below exists when you perform a remainder division operation, the calculation will be treated as normal (non-remainder) division.

- When either the dividend or the divisor is a very large value

Example: 20000000000  $\square$   $\square$  ( $\div R$ ) 17  $\square$

$\rightarrow$  Calculated as:  $20000000000 \div 17$

- When the quotient is not a positive integer, or if the remainder is not a positive integer or positive fractional value

Example:  $(\leftarrow) 5$   $(\text{SHIFT})$   $(\text{Abs})$   $(\div R)$   $2$   $(=)$

→ Calculated as:  $-5 \div 2$

## Recurring Decimal Calculations

Your calculator uses a recurring decimal when you input a value. Calculation results also can be displayed using recurring decimal form whenever applicable.

### Inputting a Recurring Decimal

When inputting a recurrent decimal, press  $(\text{ALPHA})$   $(\sqrt{\square})$   $(\overline{\square})$  before inputting its period (repetend) and then input the period up to the ending value. To input the recurring decimal  $0.909090\dots$  ( $0.\overline{90}$ ), perform the following operation: "0  $(\cdot)$   $(\text{ALPHA})$   $(\sqrt{\square})$   $(\overline{\square})$  90".

#### Important!

- If the value starts with an integer part (like:  $12.3123123\dots$ ), do not include the integer part when inputting the period ( $12.\overline{312}$ ).
- Recurring decimal input is possible only when Natural Display is selected.

**Example 1:** To input  $0.33333\dots$  ( $0.\overline{3}$ )

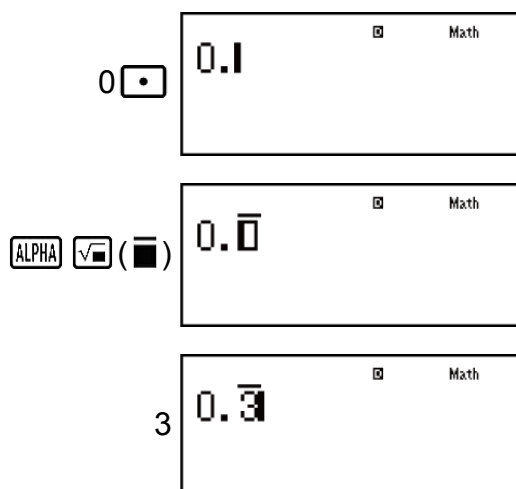

**Example 2:** To input  $1.428571428571\dots$  ( $1.\overline{428571}$ ) (MthIO-MathO)

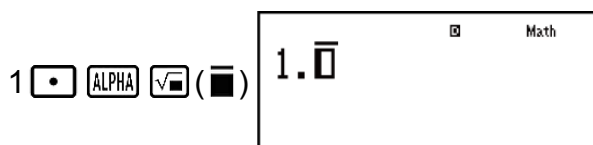

428571

**Example 3:** To calculate  $1.\overline{021} + 2.\overline{312}$

1  $\cdot$  ALPHA  $\sqrt{\square}$  (  $\square$  ) 021  $\blacktriangleright$  +  
 2  $\cdot$  ALPHA  $\sqrt{\square}$  (  $\square$  ) 312  $\equiv$

Calculation result displayed as recurring decimal value:

$\text{S+D}$

### Note

- You can specify up to 14 decimal places for the recurring decimal period. If you input more than 14 decimal places, the value will be treated as a terminating decimal and not a recurring decimal.
- Recurring decimal value input can be performed regardless of the Rdec setting on the setup menu.

## Displaying a Calculation Result as a Recurring Decimal Value

Calculation results that can be displayed as recurring decimal values will be displayed as such when ON is selected for the Rdec setting on the setup menu.

Pressing the  $\text{S+D}$  key will cycle between the available calculation result formats.

**Example 1:**  $\frac{1}{7} = 0.\overline{142857} = 0.1428571429$  (Norm 1) (MthIO-MathO)

1  $\frac{\square}{\square}$  7  $\equiv$

Display as recurring decimal:

$\text{S+D}$

Decimal value according to Norm 1 setting:

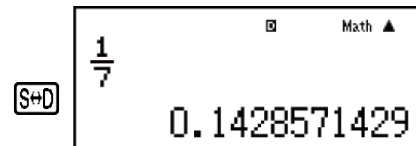

Return to initial display format (fraction):



**Example 2:**  $1 \div 7 = \frac{1}{7} = 0.\overline{142857} = 0.1428571429$  (Norm 1) (MthIO-MathO)

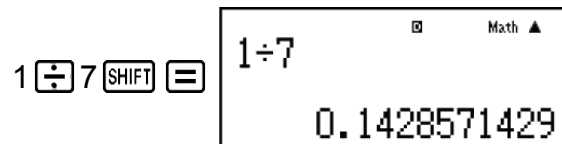

Display as fraction:

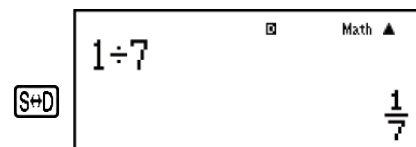

Display as recurring decimal:

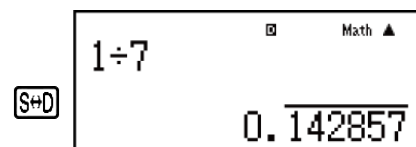

Return to initial display format (Norm 1):

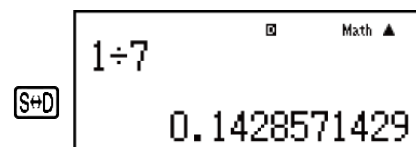

**Example 3:**  $\frac{1}{7} = 0.\overline{142857} = 0.1428571429$  (Norm 1) (LineIO)

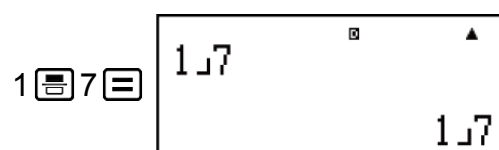

Display as recurring decimal:

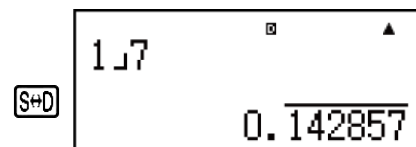

Decimal value according to Norm 1 setting:

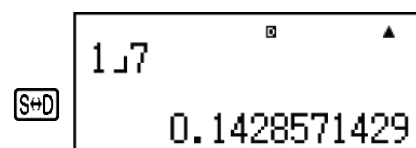

Return to initial display format (fraction):

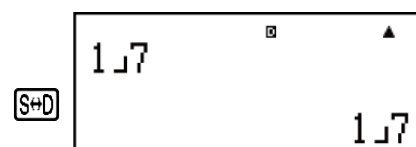

**Example 4:**  $1 \div 7 = 0.1428571429$  (Norm 1) =  $\frac{1}{7} = 0.\overline{142857}$  (LineIO)

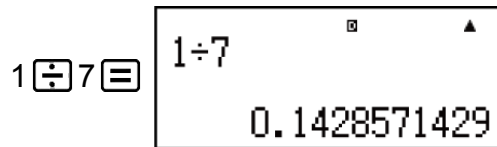

Display as fraction:

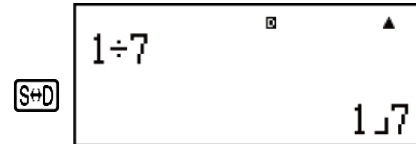

Display as recurring decimal:

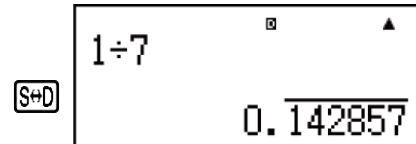

Return to initial display format (Norm 1):

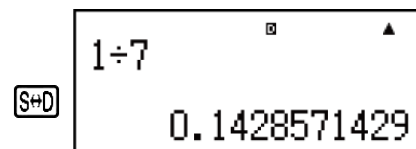

### Conditions for Displaying a Calculation Result as a Recurring Decimal

If a calculation result satisfies the following conditions, pressing  $\boxed{S \div D}$  will display it as a recurring decimal value.

- The total number of digits used in the mixed fraction (including integer, numerator, denominator, and separator symbol) must be no more than 10.
- The data size of value to be displayed as the recurring decimal must be no larger than 99 bytes. Each value and the decimal point require one byte, and each digit of the period requires one byte. The following, for example, would require of total of 8 bytes (4 bytes for the values, 1 byte for the decimal point, 3 bytes for the period):  $0.\overline{123}$ .

#### Note

- For information about switching the display format of a calculation result when OFF is selected for the Rdec setting on the setup menu, see "Toggling Calculation Results".

### Recurring Decimal Examples

**Example 1:**  $0.\overline{3} + 0.\overline{45} = 0.\overline{78}$  (MthIO-MathO)

0 [.] ALPHA [√] ( ) 3 [▶] [+]  
 0 [.] ALPHA [√] ( ) 45 [=] [S+D]

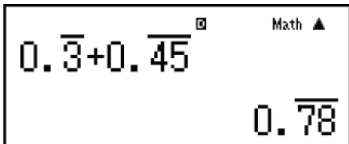

0.3 + 0.45  
 0.75

**Example 2:**  $1.\bar{6} + 2.\bar{8} = 4.\bar{5}$  (MthIO-MathO)

1 [.] ALPHA [√] ( ) 6 [▶] [+]  
 2 [.] ALPHA [√] ( ) 8 [=] [S+D]

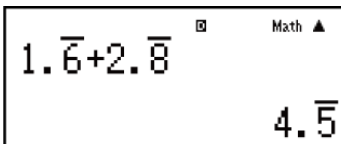

1.6 + 2.8  
 4.5

**Example 3:** To confirm the following:  $0.\overline{123} = \frac{123}{999}$ ,  $0.\overline{1234} = \frac{1234}{9999}$ ,  $0.\overline{12345} = \frac{12345}{99999}$  (MthIO-MathO)

123 [=] 999 [=]

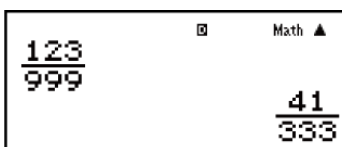

$\frac{123}{999}$   
 0.123

[S+D]

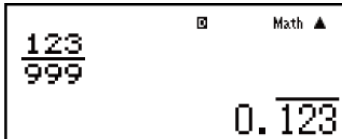

0.123

1234 [=] 9999 [=]

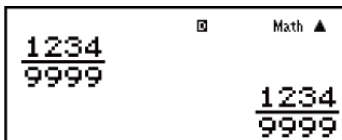

$\frac{1234}{9999}$   
 0.1234

[S+D]

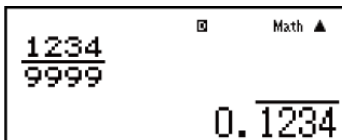

0.1234

12345 [=] 99999 [=]

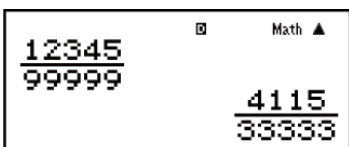

$\frac{12345}{99999}$   
 0.12345

[S+D]

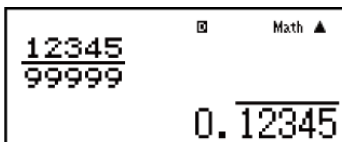

0.12345

## Prime Factorization

In the COMP Mode, a positive integer no more than 10 digits long can be factored to prime factors.

**Example 1:** To perform prime factorization on 1014

1014  $\square$ 

1014

 $\square$ SHIFT  $\square$  (FACT)  $\square$  2×3×13<sup>2</sup>

When you perform prime factorization on a value that includes a factor that is prime number with more than three digits, the part that cannot be factored will be enclosed in parentheses on the display.

**Example 2:** To perform prime factorization on 4104676 (= 2<sup>2</sup> × 1013<sup>2</sup>)

4104676  $\square$ 

4104676

 $\square$ SHIFT  $\square$  (FACT)  $\square$  2<sup>2</sup>×(1026169)

Any one of the following operations will exit prime factorization result display.

- Pressing  $\square$ SHIFT  $\square$  (FACT) or  $\square$ .
- Pressing any of the following keys:  $\square$ ENG or  $\square$ .
- Using the setup menu to change the angle unit setting (Deg, Rad, Gra) or the display digits setting (Fix, Sci, Norm).

### Note

- You will not be able to execute prime factorization while a decimal value, fraction, or negative value calculation result is displayed. Trying to do so will cause a math error (Math ERROR).
- You will not be able to execute prime factorization while the result of a calculation that uses Pol, Rec,  $\pm$ R is displayed.

## Calculation History and Replay

### Calculation History

In the COMP Mode, the calculator remembers up to approximately 200 bytes of data for the newest calculation.

You can scroll through calculation history contents using  $\blacktriangle$  and  $\blacktriangledown$ .

**Example:**

1 + 1 = 2

1  $\square$ + 1  $\square$ 

2

2 + 2 = 4

2  $\square$ + 2  $\square$ 

4

3 + 3 = 6









3  $\square$ + 3  $\square$ 

6



(Scrolls back.)  4

(Scrolls back again.)  2

### Note

- Calculation history data is all cleared whenever you press , when you change to a different calculation mode, when you change the display format, or whenever you perform the following operations:   (CLR)  (Setup)  (Yes),   (CLR)  (All)  (Yes).



## Replay

While a calculation result is on the display, you can press  or  to edit the expression you used for the previous calculation.

**Example:**  $4 \times 3 + 2 = 14$

$$4 \times 3 - 7 = 5$$

$4 \times 3 + 2 = 14$

(Continuing)     $- 7 = 5$

## Using Memory Functions

### Answer Memory (Ans)/Previous Answer Memory (PreAns)

The last calculation result obtained is stored in Ans (answer) memory. The calculation result obtained prior to the last one is stored in PreAns (previous answer) memory. Displaying the result of a new calculation will move current Ans memory contents to PreAns memory and store the new calculation results in Ans memory. PreAns memory can be used only in the COMP Mode. PreAns memory contents are cleared whenever the calculator enters another mode from the COMP Mode.

#### Using Ans Memory to Perform a Series of Calculations

**Example:** To divide the result of  $3 \times 4$  by 30 (LineIO)

$3 \times 4 = 12$

(Continuing)  $\div 30 =$

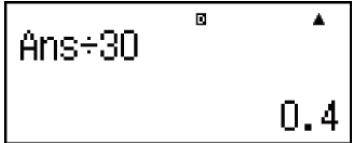

Ans÷30  
0.4



## Inputting Ans Memory Contents into an Expression

**Example:** To perform the calculations shown below:

$$123 + 456 = \underline{579} \quad 789 - \underline{579} = 210 \quad (\text{MthIO-MathO})$$

$$123 \oplus 456 \ominus \quad 579$$

(Continuing)  $789 \ominus \text{Ans} \ominus$

789-Ans	Math ▲
	210

## Using PreAns Memory

**Example:** For  $T_{k+2} = T_{k+1} + T_k$  (Fibonacci sequence), determine the sequence from  $T_1$  to  $T_5$ . Note however, that  $T_1 = 1$  and  $T_2 = 1$ .

$$T_1 = 1$$

1	Math ▲
1	1

$$(\text{Ans} = T_1 = 1)$$

$$T_2 = 1$$

1	Math ▲
1	1

$$(\text{Ans} = T_2 = 1, \text{PreAns} = T_1 = 1)$$

$$T_3 = T_2 + T_1 = 1 + 1$$

$\text{Ans} \oplus \text{ALPHA} \text{Ans} (\text{PreAns}) \ominus$

Ans+PreAns	Math ▲
	2

$$(\text{Ans} = T_3 = 2, \text{PreAns} = T_2 = 1)$$

$$T_4 = T_3 + T_2 = 2 + 1$$

Ans+PreAns	Math ▲
	3

$$(\text{Ans} = T_4 = 3, \text{PreAns} = T_3 = 2)$$

$$T_5 = T_4 + T_3 = 3 + 2$$

Ans+PreAns	Math ▲
	5

**Result:** The sequence is  $\{1, 1, 2, 3, 5\}$ .

## Variables (A, B, C, D, E, F, M, X, Y)

Your calculator has nine preset variables named A, B, C, D, E, F, M, X, and Y.

You can assign values to variables and use the variables in calculations.

### Example:

To assign the result of  $3 + 5$  to variable A

3  $\boxed{+}$  5  $\boxed{\text{SHIFT}}$   $\boxed{\text{RCL}}$  (STO)  $\boxed{\leftarrow}$  (A) 8

To multiply the contents of variable A by 10

(Continuing)  $\boxed{\text{ALPHA}}$   $\boxed{\leftarrow}$  (A)  $\boxed{\times}$  10  $\boxed{=}$  80

To recall the contents of variable A

(Continuing)  $\boxed{\text{RCL}}$   $\boxed{\leftarrow}$  (A) 8

To clear the contents of variable A

0  $\boxed{\text{SHIFT}}$   $\boxed{\text{RCL}}$  (STO)  $\boxed{\leftarrow}$  (A) 0

## Independent Memory (M)

You can add calculation results to or subtract results from independent memory.

The "M" indicator appears on the display when there is any value other than zero stored in independent memory.

### Example:

To clear the contents of M

0  $\boxed{\text{SHIFT}}$   $\boxed{\text{RCL}}$  (STO)  $\boxed{\text{M+}}$  (M) 0

To add the result of  $10 \times 5$  to M

(Continuing) 10  $\boxed{\times}$  5  $\boxed{\text{M+}}$  50

To subtract the result of  $10 + 5$  from M

(Continuing) 10  $\boxed{+}$  5  $\boxed{\text{SHIFT}}$   $\boxed{\text{M+}}$  (M-) 15

To recall the contents of M

(Continuing)  $\boxed{\text{RCL}}$   $\boxed{\text{M+}}$  (M) 35

### Note

- Variable M is used for independent memory.

## Clearing the Contents of All Memories

Ans memory, independent memory, and variable contents are retained even if you press **AC**, change the calculation mode, or turn off the calculator.

PreAns memory contents are retained even if you press **SHIFT AC** and turn off the calculator without exiting the COMP Mode.

Perform the following procedure when you want to clear the contents of all memories.

**SHIFT 9** (CLR) **2** (Memory) **=** (Yes)

# Function Calculations

---

Use the **MODE** key to enter the COMP Mode when you want to perform function calculations.

**MODE** **1** (COMP)

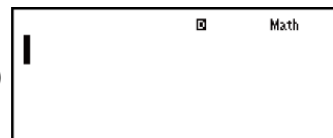

Note: Using functions can slow down a calculation, which may delay display of the result. Do not perform any subsequent operation while waiting for the calculation result to appear. To interrupt an ongoing calculation before its result appears, press **AC**.

## Pi ( $\pi$ ), Natural Logarithm Base $e$

---

$\pi$  is displayed as 3.141592654, but  $\pi = 3.14159265358980$  is used for internal calculations.

$e$  is displayed as 2.718281828, but  $e = 2.71828182845904$  is used for internal calculations.

## Trigonometric Functions

---

Specify the angle unit before performing calculations.

**Example 1:**  $\sin 30^\circ = 0.5$  (LineIO) (Angle unit: Deg)

**sin** 30 **)** **=** 0.5

**Example 2:**  $\sin^{-1} 0.5 = 30^\circ$  (LineIO) (Angle unit: Deg)

**SHIFT** **sin** (**sin**<sup>-1</sup>) 0 **.** 5 **)** **=** 30

## Hyperbolic Functions

---

Input a function from the menu that appears when you press **hyp**.  
The angle unit setting does not affect calculations.

**Example 1:**  $\sinh 1 = 1.175201194$

$$\boxed{\text{hyp}} \boxed{1} (\sinh) 1 \boxed{)} \boxed{=}$$

1.175201194

**Example 2:**  $\cosh^{-1} 1 = 0$

$$\boxed{\text{hyp}} \boxed{5} (\cosh^{-1}) 1 \boxed{)} \boxed{=}$$

0

## Angle Unit Conversion

---

$^{\circ}$ ,  $^{\text{r}}$ ,  $^{\text{g}}$ : These functions specify the angle unit.  $^{\circ}$  specifies degrees,  $^{\text{r}}$  radians, and  $^{\text{g}}$  grads.

Input a function from the menu that appears when you perform the following key operation:  $\boxed{\text{SHIFT}} \boxed{\text{Ans}} (\text{DRG} \blacktriangleright)$ .

**Example:**  $\pi/2$  radians =  $90^{\circ}$ , 50 grads =  $45^{\circ}$  (Angle unit: Deg)

$$\boxed{(} \boxed{\text{SHIFT}} \boxed{\times 10^{\square}} (\pi) \boxed{\div} 2 \boxed{)} \boxed{\text{SHIFT}} \boxed{\text{Ans}} (\text{DRG} \blacktriangleright) \boxed{2} (^{\text{r}}) \boxed{=}$$

90

$$50 \boxed{\text{SHIFT}} \boxed{\text{Ans}} (\text{DRG} \blacktriangleright) \boxed{3} (^{\text{g}}) \boxed{=}$$

45

## Exponential Functions

---

Note that the input method is different depending upon whether you are using Natural Display or Linear Display.

**Example:** To calculate  $e^5 \times 2$  to three significant digits (Sci 3)

$$\boxed{\text{SHIFT}} \boxed{\text{MODE}} (\text{SETUP}) \boxed{7} (\text{Sci}) \boxed{3}$$

$$(\text{MthIO-MathO}) \boxed{\text{SHIFT}} \boxed{\ln} (e^{\blacksquare}) 5 \boxed{\blacktriangleright} \boxed{\times} 2 \boxed{=}$$

$2.97 \times 10^2$

$$(\text{LineIO}) \boxed{\text{SHIFT}} \boxed{\ln} (e^{\blacksquare}) 5 \boxed{)} \boxed{\times} 2 \boxed{=}$$

$2.97 \times 10^2$

## Logarithmic Functions

---

Use the  $\boxed{\log}$  key to input  $\log_{ab}$  as  $\log(a,b)$ .

Base 10 is the default setting if you do not input anything for  $a$ .

The  $\boxed{\log_{a\blacksquare}}$  key also can be used for input, but only while Natural Display is selected. In this case, you must input a value for the base.

**Example 1:**  $\log_{10} 1000 = \log 1000 = 3$

$$\boxed{\log} 1000 \boxed{)} \boxed{=}$$

3

**Example 2:**  $\log_2 16 = 4$

$$\boxed{\log} \boxed{2} \boxed{\text{SHIFT}} \boxed{)} \boxed{(,)} \boxed{16} \boxed{)} \boxed{=} \quad 4$$

(MthIO-MathO, MthIO-LineO)  $\boxed{\log_{\square}} \boxed{2} \boxed{\blacktriangleright} \boxed{16} \boxed{=} \quad 4$

**Example 3:**  $\log_2(4^3) = 6$  (MthIO-MathO, MthIO-LineO)

$$\boxed{\log_{\square}} \boxed{2} \boxed{\blacktriangleright} \boxed{4} \boxed{x^3} \boxed{=} \quad 6$$

**Example 4:**  $\log_2(4)^3 = 8$  (MthIO-MathO, MthIO-LineO)

$$\boxed{\log_{\square}} \boxed{2} \boxed{\blacktriangleright} \boxed{4} \boxed{\blacktriangleright} \boxed{x^3} \boxed{=} \quad 8$$

**Example 5:** To calculate  $\ln 90$  ( $= \log_e 90$ ) to three significant digits (Sci 3)

$$\boxed{\text{SHIFT}} \boxed{\text{MODE}} \boxed{(\text{SETUP})} \boxed{7} \boxed{(\text{Sci})} \boxed{3} \quad 4.50 \times 10^0$$

$$\boxed{\ln} \boxed{90} \boxed{)} \boxed{=} \quad 4.50 \times 10^0$$

## Power Functions and Power Root Functions

---

Note that the input methods for  $x^{\square}$ ,  $\sqrt{\square}$ ,  $\sqrt[\square]{\square}$ , and  $\sqrt[\square]{\square}$  are different depending upon whether you are using Natural Display or Linear Display.

**Example 1:**  $1.2 \times 10^3 = 1200$  (MthIO-MathO)

$$1 \boxed{\cdot} \boxed{2} \boxed{\times} \boxed{10} \boxed{x^{\square}} \boxed{3} \boxed{=} \quad 1200$$

**Example 2:**  $(1 + 1)^{2+2} = 16$  (MthIO-MathO)

$$\boxed{(} \boxed{1} \boxed{+} \boxed{1} \boxed{)} \boxed{x^{\square}} \boxed{2} \boxed{+} \boxed{2} \boxed{=} \quad 16$$

**Example 3:**  $(5^2)^3 = 15625$

$$\boxed{(} \boxed{5} \boxed{x^2} \boxed{)} \boxed{x^3} \boxed{=} \quad 15625$$

**Example 4:**  $\sqrt[5]{32} = 2$

(MthIO-MathO)  $\boxed{\text{SHIFT}} \boxed{x^{\square}} \boxed{(\sqrt[\square]{\square})} \boxed{5} \boxed{\blacktriangleright} \boxed{32} \boxed{=} \quad 2$

(LineIO)  $5 \boxed{\text{SHIFT}} \boxed{x^{\square}} \boxed{(\sqrt[\square]{\square})} \boxed{32} \boxed{)} \boxed{=} \quad 2$

**Example 5:** To calculate  $\sqrt{2} \times 3$  ( $= 3\sqrt{2} = 4.242640687\dots$ ) to three decimal places (Fix 3)

$$\boxed{\text{SHIFT}} \boxed{\text{MODE}} \boxed{(\text{SETUP})} \boxed{6} \boxed{(\text{Fix})} \boxed{3}$$

(MthIO-MathO)  $\sqrt{\square}$  2  $\blacktriangleright$   $\times$  3  $\equiv$

$3\sqrt{2}$

$\text{SHIFT}$   $\equiv$

4.243

(LineIO)  $\sqrt{\square}$  2  $\square$   $\times$  3  $\equiv$

4.243

**Example 6:**  ${}^3\sqrt{5} + {}^3\sqrt{-27} = -1.290024053$

(LineIO)  $\text{SHIFT}$   $\sqrt{\square}$  ( ${}^3\sqrt{\square}$ ) 5  $\square$   $+$

$\text{SHIFT}$   $\sqrt{\square}$  ( ${}^3\sqrt{\square}$ )  $(-)$  27  $\square$   $\equiv$

-1.290024053

**Example 7:**  $\frac{1}{\frac{1}{3} - \frac{1}{4}} = 12$

(LineIO)  $(\frac{1}{3} \text{  $\times$  } 1 - \frac{1}{4} \text{  $\times$  } 1) \text{  $\times$  } 1 \equiv$

12

### Note

- The following functions cannot be input in consecutive sequence:  $x^2$ ,  $x^3$ ,  $x^\square$ ,  $x^{-1}$ . If you input 2  $\text{ $\square$  } x^2 \text{  $\square$  } x^2$ , for example, the final  $\text{ $\square$  } x^2$  will be ignored. To input  $2^{2^2}$ , input 2  $\text{ $\square$  } x^2$ , press the  $\blacktriangleleft$  key, and then press  $\text{ $\square$  } x^2$  (MthIO-MathO).

## Rectangular-Polar Coordinate Conversion

Pol converts rectangular coordinates to polar coordinates, while Rec converts polar coordinates to rectangular coordinates.

$$\text{Pol}(x, y) = (r, \theta)$$

$$\text{Rec}(r, \theta) = (x, y)$$

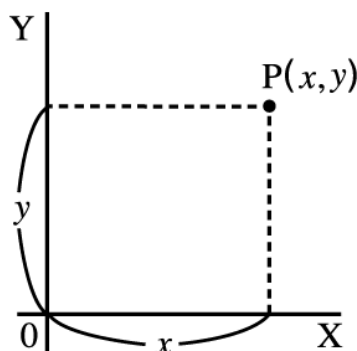

(1)

(1) Rectangular Coordinates (Rec)

Pol  $\rightarrow$   
 $\leftarrow$  Rec

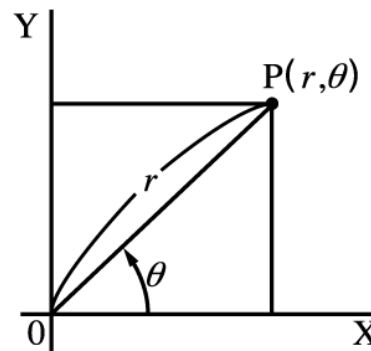

(2)

(2) Polar Coordinates (Pol)

Specify the angle unit before performing calculations.

The calculation result for  $r$  and  $\theta$  and for  $x$  and  $y$  are each assigned respectively to variables X and Y.

Calculation result  $\theta$  is displayed in the range of  $-180^\circ < \theta \leq 180^\circ$ .

**Example 1:** To convert rectangular coordinates  $(\sqrt{2}, \sqrt{2})$  to polar coordinates (Angle unit: Deg)

(MthIO-MathO)

$\boxed{\text{SHIFT}} \boxed{+} (\text{Pol}) \boxed{\sqrt{\square}} \boxed{2} \boxed{\blacktriangleright} \boxed{\text{SHIFT}} \boxed{)} \boxed{(,)} \boxed{\sqrt{\square}} \boxed{2} \boxed{\blacktriangleright} \boxed{)} \boxed{=}$   $r = 2, \theta = 45$

(LineIO)

$\boxed{\text{SHIFT}} \boxed{+} (\text{Pol}) \boxed{\sqrt{\square}} \boxed{2} \boxed{)} \boxed{\text{SHIFT}} \boxed{)} \boxed{(,)} \boxed{\sqrt{\square}} \boxed{2} \boxed{)} \boxed{)} \boxed{=}$   $r = 2$   
 $\theta = 45$

**Example 2:** To convert polar coordinates  $(\sqrt{2}, 45^\circ)$  to rectangular coordinates (Angle unit: Deg)

(MthIO-MathO)

$\boxed{\text{SHIFT}} \boxed{-} (\text{Rec}) \boxed{\sqrt{\square}} \boxed{2} \boxed{\blacktriangleright} \boxed{\text{SHIFT}} \boxed{)} \boxed{(,)} \boxed{45} \boxed{)} \boxed{=}$   $X = 1, Y = 1$

## Factorial Function (!)

---

**Example:**  $(5 + 3)! = 40320$

$\boxed{(} \boxed{5} \boxed{+} \boxed{3} \boxed{)} \boxed{\text{SHIFT}} \boxed{x!} \boxed{(x!)} \boxed{=}$  40320

## Absolute Value Function (Abs)

---

Note that the input method is different depending upon whether you are using Natural Display or Linear Display.

**Example:**  $|2 - 7| \times 2 = 10$

(MthIO-MathO)

$\boxed{\text{Abs}} \boxed{2} \boxed{-} \boxed{7} \boxed{\blacktriangleright} \boxed{\times} \boxed{2} \boxed{=}$  10

(LineIO)

$\boxed{\text{Abs}} \boxed{2} \boxed{-} \boxed{7} \boxed{)} \boxed{\times} \boxed{2} \boxed{=}$  10



## Random Number (Ran#)

---

Function that generates a pseudo random number in the range of 0.000 to 0.999.

The result is displayed as a fraction when Natural Display is selected.

**Example:** Generate three 3-digit random numbers.

The random 3-digit decimal values are converted to 3-digit integer values by multiplying by 1000.

1000	[SHIFT] [.] (Ran#) [=]	634
	[=]	92
	[=]	175

(Results shown here are for illustrative purposes only. Actual results will differ.)

## Random Integer (RanInt#)

---

For input of the function of the form  $\text{RanInt\#}(a, b)$ , which generates a random integer within the range of  $a$  to  $b$ .

**Example:** To generate random integers in the range of 1 to 6

[ALPHA] [.] (RanInt) 1	[SHIFT] [)] (,) 6 [)] [=]	2
	[=]	6
	[=]	1

(Results shown here are for illustrative purposes only. Actual results will differ.)

## Permutation ( $nPr$ ) and Combination ( $nCr$ )

---

**Example:** To determine the number of permutations and combinations possible when selecting four people from a group of 10.

Permutations: 10	[SHIFT] [x] ( $nPr$ ) 4 [=]	5040
Combinations: 10	[SHIFT] [÷] ( $nCr$ ) 4 [=]	210

# Rounding Function (Rnd)

---

The argument of this function is made a decimal value and then rounded in accordance with the current number of display digits setting (Norm, Fix, or Sci).

With Norm 1 or Norm 2, the argument is rounded off to 10 digits.

With Fix and Sci, the argument is rounded off to the specified digit.

When Fix 3 is the display digits setting, for example, the result of  $10 \div 3$  is displayed as 3.333, while the calculator maintains a value of 3.333333333333333 (15 digits) internally for calculation.

In the case of  $\text{Rnd}(10 \div 3) = 3.333$  (with Fix 3), both the displayed value and the calculator's internal value become 3.333.

Because of this a series of calculations will produce different results depending on whether Rnd is used ( $\text{Rnd}(10 \div 3) \times 3 = 9.999$ ) or not used ( $10 \div 3 \times 3 = 10.000$ ).

**Example:** To perform the following calculations when Fix 3 is selected for the number of display digits:  $10 \div 3 \times 3$  and  $\text{Rnd}(10 \div 3) \times 3$  (LineIO)

$\text{SHIFT}$ $\text{MODE}$ (SETUP) $\text{6}$ (Fix) $\text{3}$	
$10 \div 3 \times 3 =$	10.000
$\text{SHIFT}$ $\text{0}$ (Rnd) $10 \div 3 \text{ ) } \times 3 =$	9.999

# Greatest Common Divisor (GCD) and Least Common Multiple (LCM)

---

## Greatest Common Divisor (GCD)

GCD determines the greatest common divisor of two values.

**Example:** To determine the greatest common divisor of 28 and 35

$\text{ALPHA}$ $\times$ (GCD) 28 $\text{SHIFT}$ $\text{ ) }$ (,) 35 $\text{ ) }$ $=$	7
--	---

## Least Common Multiple (LCM)

LCM determines the least common multiple of two values.

**Example:** To determine the least common multiple of 9 and 15

$\text{ALPHA}$ $\div$ (LCM) 9 $\text{SHIFT}$ $\text{ ) }$ (,) 15 $\text{ ) }$ $=$	45
---	----

# Integer Part of a Value (Int) and Largest Integer that does not Exceed a Value (Intg)

---

## Integer Part of a Value (Int)

Extracts the integer part of a value.

**Example:** To extract the integer part of -3.5

`ALPHA` `+` `(Int)` `(-)` `3` `.` `5` `)` `=` -3

## Largest Integer that does not Exceed a Value (Intg)

Determines the largest integer that does not exceed a value.

**Example:** To determine the largest integer that does not exceed -3.5

`ALPHA` `-` `(Intg)` `(-)` `3` `.` `5` `)` `=` -4

# Using Calculation Modes

## Statistical Calculations (STAT)

To start a statistical calculation, perform the key operation **MODE** **2** (STAT) to enter the STAT Mode and then use the screen that appears to select the type of calculation you want to perform.

1: 1-VAR	2: A+BX
3: $\_+CX^2$	4: $\ln X$
5: $e^X$	6: $A \cdot B^X$
7: $A \cdot X^B$	8: $1/X$

To select this type of statistical calculation: (Regression formula shown in parentheses)	Press this key:
Single-variable (X)	<b>1</b> (1-VAR)
Paired-variable (X, Y), linear regression ( $y = A + Bx$ )	<b>2</b> (A+BX)
Paired-variable (X, Y), quadratic regression ( $y = A + Bx + Cx^2$ )	<b>3</b> ( $\_+CX^2$ )
Paired-variable (X, Y), logarithmic regression ( $y = A + B\ln x$ )	<b>4</b> ( $\ln X$ )
Paired-variable (X, Y), <i>e</i> exponential regression ( $y = A e^{Bx}$ )	<b>5</b> ( $e^X$ )
Paired-variable (X, Y), <i>ab</i> exponential regression ( $y = AB^x$ )	<b>6</b> ( $A \cdot B^X$ )
Paired-variable (X, Y), power regression ( $y = Ax^B$ )	<b>7</b> ( $A \cdot X^B$ )
Paired-variable (X, Y), inverse regression ( $y = A + B/x$ )	<b>8</b> ( $1/X$ )

Pressing any of the above keys (**1** to **8**) displays the Statistics Editor.

## Note

- When you want to change the calculation type after entering the STAT Mode, perform the key operation  $\text{SHIFT}$   $\boxed{1}$  (STAT)  $\boxed{1}$  (Type) to display the calculation type selection screen.

## Inputting Data

Use the Statistics Editor to input data. Perform the following key operation to display the Statistics Editor:  $\text{SHIFT}$   $\boxed{1}$  (STAT)  $\boxed{2}$  (Data).

The Statistics Editor provides 40 rows for data input when there is an X column only or when there are X and Y columns, 20 rows when there are X and FREQ columns, or 26 rows when there are X, Y, and FREQ columns.

## Note

- Use the FREQ (frequency) column to input the quantity (frequency) of identical data items. Display of the FREQ column can be turned on (displayed) or off (not displayed) using the Stat Format setting on the setup menu.

**Example 1:** To select linear regression and input the following data: (170, 66), (173, 68), (179, 75)

$\text{MODE}$   $\boxed{2}$  (STAT)  $\boxed{2}$  (A+BX)

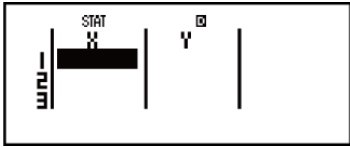

170  $\boxed{=}$  173  $\boxed{=}$  179  $\boxed{=}$   $\blacktriangledown$   $\blacktriangleright$

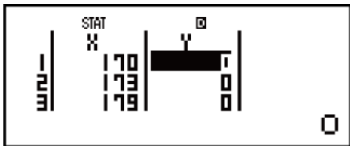

66  $\boxed{=}$  68  $\boxed{=}$  75  $\boxed{=}$

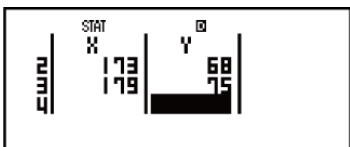

## Important!

- All data currently input in the Statistics Editor is deleted whenever you exit the STAT Mode, switch between the single-variable and a paired-variable statistical calculation type, or change the Stat Format setting on the setup menu.
- The following operations are not supported by the Statistics Editor:  $\text{M}+$ ,  $\text{SHIFT}$   $\text{M}+$  (M-),  $\text{SHIFT}$   $\text{RCL}$  (STO). Pol, Rec,  $\pm$ R, and multi-statements also cannot be input with the Statistics Editor.

### To change the data in a cell:

In the Statistics Editor, move the cursor to the cell that contains the data you want to change, input the new data, and then press  $\boxed{=}$ .

### To delete a line:

In the Statistics Editor, move the cursor to the line that you want to delete and then press  $\boxed{DEL}$ .

### To insert a line:

In the Statistics Editor, move the cursor to the location where you want to insert the line and then perform the following key operation:

$\boxed{SHIFT}$   $\boxed{1}$  (STAT)  $\boxed{3}$  (Edit)  $\boxed{1}$  (Ins).

### To delete all Statistics Editor contents:

In the Statistics Editor, perform the following key operation:

$\boxed{SHIFT}$   $\boxed{1}$  (STAT)  $\boxed{3}$  (Edit)  $\boxed{2}$  (Del-A).

## Statistics Calculation Screen

The Statistics Calculation Screen is for performing statistical calculations with the data you input with the Statistics Editor. Pressing the  $\boxed{AC}$  key while the Statistics Editor is displayed switches to the Statistics Calculation Screen.

## Using the Statistics Menu

While the Statistics Calculation Screen is on the display, press  $\boxed{SHIFT}$   $\boxed{1}$  (STAT) to display the Statistics Menu.

The content to the Statistics Menu depends on whether the currently selected statistical operation type uses a single variable or paired variables.

```
1:Type   2:Data
3:Sum    4:Var
5:MinMax
```

Single-variable Statistics

```
1:Type   2:Data
3:Sum    4:Var
5:Reg    6:MinMax
```

Paired-variables Statistics

## Statistics Menu Items

### Common Items

Select this menu item:	When you want to obtain this:
<b>1</b> (Type)	Display the calculation type selection screen
<b>2</b> (Data)	Display the Statistics Editor
<b>3</b> (Sum)	Display the Sum sub-menu of commands for calculating sums
<b>4</b> (Var)	Display the Var sub-menu of commands for calculating the mean, standard deviation, etc.
Single-variable: <b>5</b> (MinMax) Paired-variable: <b>6</b> (MinMax)	Display the MinMax sub-menu of commands for obtaining maximum and minimum values

### Single-variable (1-VAR) Statistical Calculation Commands

#### Sum Sub-menu (**SHIFT** **1** (STAT) **3** (Sum))

Select this menu item:	When you want to obtain this:
<b>1</b> ( $\sum x^2$ )	Sum of squares of the sample data
<b>2</b> ( $\sum x$ )	Sum of the sample data

#### Var Sub-menu (**SHIFT** **1** (STAT) **4** (Var))

Select this menu item:	When you want to obtain this:
<b>1</b> ( $n$ )	Number of samples
<b>2</b> ( $\bar{x}$ )	Mean of the sample data
<b>3</b> ( $\sigma_x$ )	Population standard deviation
<b>4</b> ( $s_x$ )	Sample standard deviation

**MinMax Sub-menu (SHIFT 1 (STAT) 5 (MinMax))**

Select this menu item:	When you want to obtain this:
1 (minX)	Minimum value
2 (maxX)	Maximum value
3 (Q1)	First quartile
4 (med)	Median
5 (Q3)	Third quartile

**Commands when Linear Regression Calculation (A+BX) Is Selected  
Sum Sub-menu (SHIFT 1 (STAT) 3 (Sum))**

Select this menu item:	When you want to obtain this:
1 ( $\sum x^2$ )	Sum of squares of the X-data
2 ( $\sum x$ )	Sum of the X-data
3 ( $\sum y^2$ )	Sum of squares of the Y-data
4 ( $\sum y$ )	Sum of the Y-data
5 ( $\sum xy$ )	Sum of products of the X-data and Y-data
6 ( $\sum x^3$ )	Sum of cubes of the X-data
7 ( $\sum x^2y$ )	Sum of (X-data squares $\times$ Y-data)
8 ( $\sum x^4$ )	Sum of biquadrate of the X-data

**Var Sub-menu (SHIFT 1 (STAT) 4 (Var))**

Select this menu item:	When you want to obtain this:
1 ( $n$ )	Number of samples
2 ( $\bar{x}$ )	Mean of the X-data



<b>3</b> ( $\sigma_x$ )	Population standard deviation of the X-data
<b>4</b> ( $s_x$ )	Sample standard deviation of the X-data
<b>5</b> ( $\bar{y}$ )	Mean of the Y-data
<b>6</b> ( $\sigma_y$ )	Population standard deviation of the Y-data
<b>7</b> ( $s_y$ )	Sample standard deviation of the Y-data

**Reg Sub-menu ( **SHIFT** **1** (STAT) **5** (Reg))**

Select this menu item:	When you want to obtain this:
<b>1</b> (A)	Regression coefficient constant term A
<b>2</b> (B)	Regression coefficient B
<b>3</b> ( $r$ )	Correlation coefficient $r$
<b>4</b> ( $\hat{x}$ )	Estimated value of X
<b>5</b> ( $\hat{y}$ )	Estimated value of Y

**MinMax Sub-menu ( **SHIFT** **1** (STAT) **6** (MinMax))**

Select this menu item:	When you want to obtain this:
<b>1</b> (minX)	Minimum value of the X-data
<b>2</b> (maxX)	Maximum value of the X-data
<b>3</b> (minY)	Minimum value of the Y-data
<b>4</b> (maxY)	Maximum value of the Y-data

## Commands when Quadratic Regression Calculation ( $\_+CX^2$ ) Is Selected

Reg Sub-menu ( **SHIFT** **1** (STAT) **5** (Reg))

Select this menu item:	When you want to obtain this:
<b>1</b> (A)	Regression coefficient constant term A
<b>2</b> (B)	Linear coefficient B of the regression coefficients
<b>3</b> (C)	Quadratic coefficient C of the regression coefficients
<b>4</b> ( $\hat{x}_1$ )	Estimated value of $x_1$
<b>5</b> ( $\hat{x}_2$ )	Estimated value of $x_2$
<b>6</b> ( $\hat{y}$ )	Estimated value of $y$

### Note

- $\hat{x}$ ,  $\hat{x}_1$ ,  $\hat{x}_2$  and  $\hat{y}$  are not variables. They are commands of the type that take an argument immediately before them. See "Calculating Estimated Values" for more information.

**Example 2:** To input the single-variable data  $x = \{1, 2, 2, 3, 3, 3, 4, 4, 5\}$ , using the FREQ column to specify the number of repeats for each items ( $\{x_n; \text{freq}_n\} = \{1;1, 2;2, 3;3, 4;2, 5;1\}$ ), and calculate the mean and population standard deviation.

**SHIFT** **MODE** (SETUP) **3** (STAT) **1** (ON)  
**MODE** **2** (STAT) **1** (1-VAR)  
 1 **2** **3** **4** **5** **2** **1**  
 1 **2** **3** **2**



**AC** **SHIFT** **1** (STAT) **4** (Var) **2** ( $\bar{x}$ ) **=** 3  
**AC** **SHIFT** **1** (STAT) **4** (Var) **3** ( $\sigma_x$ ) **=** 1.154700538

**Results:** Mean: 3, Population Standard Deviation: 1.154700538

**Example 3:** To calculate the linear regression and logarithmic regression correlation coefficients for the following paired-variable data and determine the regression formula for the strongest correlation:  $(x, y) = (20, 3150)$ ,

(110, 7310), (200, 8800), (290, 9310). Specify Fix 3 (three decimal places) for results.

[SHIFT] [MODE] (SETUP) [▼] [3] (STAT) [2] (OFF)  
     [SHIFT] [MODE] (SETUP) [6] (Fix) [3]  
         [MODE] [2] (STAT) [2] (A+BX)  
 20 [=] 110 [=] 200 [=] 290 [=] [▼] [▶]  
 3150 [=] 7310 [=] 8800 [=] 9310 [=]

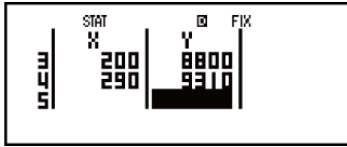

[AC] [SHIFT] [1] (STAT) [5] (Reg) [3] ( $r$ ) [=] 0.923

[AC] [SHIFT] [1] (STAT) [1] (Type) [4] (ln X)  
 [AC] [SHIFT] [1] (STAT) [5] (Reg) [3] ( $r$ ) [=] 0.998

[AC] [SHIFT] [1] (STAT) [5] (Reg) [1] (A) [=] -3857.984

[AC] [SHIFT] [1] (STAT) [5] (Reg) [2] (B) [=] 2357.532

**Results:** Linear Regression Correlation Coefficient: 0.923  
 Logarithmic Regression Correlation Coefficient: 0.998  
 Logarithmic Regression Formula:  $y = -3857.984 + 2357.532\ln x$

## Calculating Estimated Values

Based on the regression formula obtained by paired-variable statistical calculation, the estimated value of  $y$  can be calculated for a given  $x$ -value. The corresponding  $x$ -value (two values,  $x_1$  and  $x_2$ , in the case of quadratic regression) also can be calculated for a value of  $y$  in the regression formula.

**Example 4:** To determine the estimate value for  $x$  when  $y = -130$  in the regression formula produced by logarithmic regression of the data in Example 3. Specify Fix 3 for the result. (Perform the following operation after completing the operations in Example 3.)

[AC] [(-)] 130 [SHIFT] [1] (STAT) [5] (Reg) [4] ( $\hat{x}$ ) [=] 4.861

### Important!

- Regression coefficient, correlation coefficient, and estimated value calculations can take considerable time when there are a large number of data items.

# Creating a Numerical Table from Two Functions (TABLE)

---

TABLE generates a numerical table based on one or two functions. You can use the function  $f(x)$  or the two functions  $f(x)$  and  $g(x)$ . See "Configuring the Calculator Setup" for more information. Perform the following steps to generate a numerical table.

1. Press **MODE** **3** (TABLE) to enter the TABLE Mode.

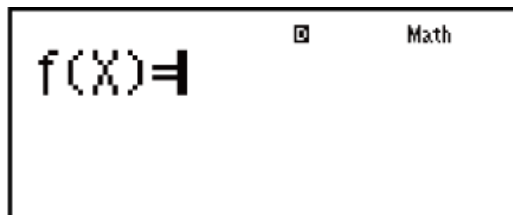

2. Use the X variable to input two functions, one in the format  $f(x)$  and the other in the format  $g(x)$ .
  - Be sure to input the X variable (**ALPHA** **□** (X)) when generating a numerical table. Any variable other than X is handled as a constant.
  - If you are using a single function, input a function in the format  $f(x)$  only.
  - The following cannot be used in the function: Pol, Rec.
3. In response to the prompts that appear, input the values you want to use, pressing **≡** after each one.

For this prompt:	Input this:
Start?	Input the lower limit of X (Default = 1).
End?	Input the upper limit of X (Default = 5). <b>Note:</b> Make sure that the End value is always greater than the Start value.

Step?	<p>Input the increment step (Default = 1).</p> <p><b>Note:</b> The Step specifies by how much the Start value should be sequentially incremented as the numerical table is generated. If you specify Start = 1 and Step = 1, X sequentially will be assigned the values 1, 2, 3, 4, and so on to generate the numerical table until the End value is reached.</p>
-------	---

- Inputting the Step value and pressing  $\boxed{\equiv}$  generates and displays the numerical table in accordance with the parameters you specified.
- Pressing  $\boxed{AC}$  while the numerical table screen is displayed will return to the function input screen in step 2.

**Example:** To generate a numerical table for the functions  $f(x) = x^2 + \frac{1}{2}$  and  $g(x) = x^2 - \frac{1}{2}$  for the range  $-1 \leq x \leq 1$ , incremented in steps of 0.5 (MthIO-MathO)

$\boxed{MODE} \boxed{3} (TABLE)$

$f(X)=$

$\boxed{SHIFT} \boxed{MODE} (SETUP) \downarrow \boxed{4} (TABLE) \boxed{2} (f(x),g(x))$   
 $\boxed{ALPHA} \boxed{)} (X) \boxed{x^2} \boxed{+} \boxed{1} \boxed{\equiv} \boxed{2}$

$f(X)=X^2+\frac{1}{2}$

$\boxed{\equiv}$

$g(X)=$

- Pressing  $\boxed{\equiv}$  without inputting anything for  $g(x)$  will generate a numerical table based on  $f(x)$  only.

$\boxed{ALPHA} \boxed{)} (X) \boxed{x^2} \boxed{-} \boxed{1} \boxed{\equiv} \boxed{2}$

$g(X)=X^2-\frac{1}{2}$

$\boxed{\equiv} \boxed{\leftarrow} \boxed{1} \boxed{\equiv} \boxed{1} \boxed{\equiv} \boxed{0} \boxed{\cdot} \boxed{5} \boxed{\equiv}$

	X	F(X)	G(X)
1	-1	1.5	0.5
2	-0.5	0.75	-0.25
3	0	0.5	-0.5
			-1

## Note

---

- You can use the numerical table screen for viewing values only. Table contents cannot be edited.
- The numerical table generation operation causes the contents of variable X to be changed.
- The maximum number of rows in the generated numerical table depends on the setup menu table setting. Up to 30 rows are supported for the " $f(x)$ " setting, while 20 rows are supported for the " $f(x),g(x)$ " setting.

## Important!

---

- The function you input for numerical table generation is deleted whenever you display the setup menu in the TABLE Mode and switch between Natural Display and Linear Display.

# Technical Information

## Errors

The calculator will display an error message whenever an error occurs for any reason during a calculation.

There are two ways to exit an error message display: Pressing ◀ or ▶ to display the location of the error, or pressing **AC** to clear the message and calculation.

### Displaying the Location of an Error

While an error message is displayed, press ◀ or ▶ to return to the calculation screen. The cursor will be positioned at the location where the error occurred, ready for input. Make the necessary corrections to the calculation and execute it again.

**Example:** When you input  $14 \div 0 \times 2$  by mistake instead of  $14 \div 10 \times 2$  (MthIO-MathO)

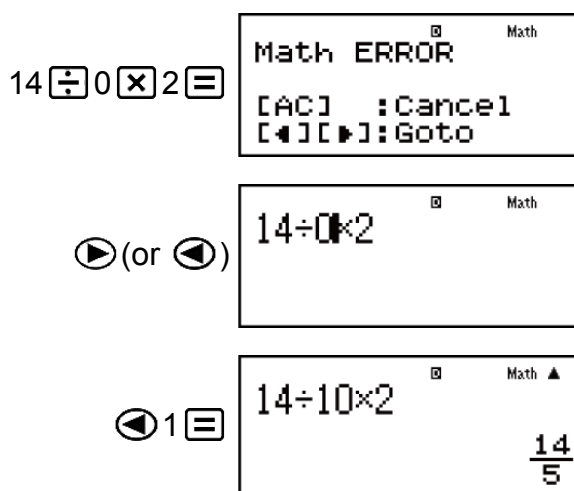

### Clearing the Error Message

While an error message is displayed, press **AC** to return to the calculation screen. Note that this also clears the calculation that contained the error.

### Error Messages

#### Math ERROR

**Cause:**

- The intermediate or final result of the calculation you are performing exceeds the allowable calculation range.

- Your input exceeds the allowable input range (particularly when using functions).
- The calculation you are performing contains an illegal mathematical operation (such as division by zero).

**Action:**

- Check the input values, reduce the number of digits, and try again.
- When using independent memory or a variable as the argument of a function, make sure that the memory or variable value is within the allowable range for the function.

## Stack ERROR

**Cause:**

- The calculation you are performing has caused the capacity of the numeric stack or the command stack to be exceeded.

**Action:**

- Simplify the calculation expression so it does not exceed the capacity of the stack.
- Try splitting the calculation into two or more parts.

## Syntax ERROR

**Cause:**

- There is a problem with the format of the calculation you are performing.

**Action:**

- Make necessary corrections.

## Argument ERROR

**Cause:**

- There is a problem with the argument of the calculation you are performing.

**Action:**

- Make necessary corrections.

## Insufficient MEM Error

**Cause:**

- An attempt to generate a numerical table in the TABLE Mode whose conditions cause it to exceed the maximum number of allowable rows. The maximum number of rows is 30 when " $f(x)$ " is selected for the setup menu table setting and 20 when " $f(x),g(x)$ " is selected.



**Action:**

- Narrow the table calculation range by changing the Start, End, and Step values, and try again.

## Before Assuming Malfunction of the Calculator...

---

Perform the following steps whenever an error occurs during a calculation or when calculation results are not what you expected. If one step does not correct the problem, move on to the next step.

Note that you should make separate copies of important data before performing these steps.

1. Check the calculation expression to make sure that it does not contain any errors.
2. Make sure that you are using the correct mode for the type of calculation you are trying to perform.
3. If the above steps do not correct your problem, press the **ON** key. This will cause the calculator to perform a routine that checks whether calculation functions are operating correctly. If the calculator discovers any abnormality, it automatically initializes the calculation mode and clears memory contents. For details about initialized settings, see "Configuring the Calculator Setup".
4. Initialize all modes and settings by performing the following operation: **SHIFT** **9** (CLR) **1** (Setup) **≡** (Yes).

## Replacing the Battery

---

The battery needs to be replaced after a specific number of years. Also, replace the battery immediately after display figures become dim.

A low battery is indicated by a dim display, even if contrast is adjusted, or by failure of figures to appear on the display immediately after you turn on the calculator. If this happens, replace the battery with a new one.

**Important!**

- Removing the battery will cause all of the calculator's memory contents to be deleted.

1. Press **SHIFT** **AC** (OFF) to turn off the calculator.
2. Loosen the screws on the back of the calculator and then remove the cover.

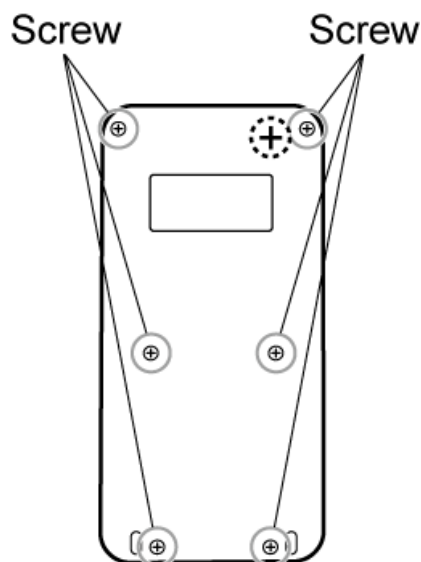

3. Remove the battery, and then load a new battery with its plus (+) and minus (-) ends facing correctly.
4. Replace the cover.
5. Initialize the calculator: **ON** **SHIFT** **9** (CLR) **3** (All) **≡** (Yes).
  - Do not skip the above step!

## Calculation Priority Sequence

---

The priority sequence of input calculations is evaluated in accordance with the rules below.

When the priority of two expressions is the same, the calculation is performed from left to right.

1	Parenthetical expressions
2	Functions that require an argument to the right and a closing parenthesis ")" following the argument
3	Functions that come after the input value ( $x^2$ , $x^3$ , $x^{-1}$ , $x!$ , $^{\circ}$ , $^{\circ}$ , $r$ , $g$ , $\%$ ), powers ( $x^{\blacksquare}$ ), roots ( $\blacksquare\sqrt{\square}$ )
4	Fractions
5	Negative sign ((-))
6	STAT Mode estimated values ( $\hat{x}$ , $\hat{y}$ , $\hat{x}_1$ , $\hat{x}_2$ )
7	Multiplication where the multiplication sign is omitted
8	Permutation ( $nPr$ ), combination ( $nCr$ )

9	Multiplication ( $\times$ ), division ( $\div$ ), remainder calculations ( $\div R$ )
10	Addition (+), subtraction (-)

### Note

- When squaring a negative value (such as -2), the value being squared must be enclosed in parentheses (  $( (-) 2 ) x^2 =$  ). Since  $x^2$  has a higher priority than the negative sign, inputting  $(-) 2 x^2 =$  would result in the squaring of 2 and then appending a negative sign to the result.
- Always keep the priority sequence in mind, and enclose negative values in parentheses when required.

## Calculation Ranges, Number of Digits, and Precision

The calculation range, number of digits used for internal calculation, and calculation precision depends on the type of calculation you are performing.

### Calculation Range and Precision

Calculation Range	$\pm 1 \times 10^{-99}$ to $\pm 9.999999999 \times 10^{99}$ or 0
Number of Digits for Internal Calculation	15 digits
Precision	In general, $\pm 1$ at the 10th digit for a single calculation. Precision for exponential display is $\pm 1$ at the least significant digit. Errors are cumulative in the case of consecutive calculations.

### Function Calculation Input Ranges and Precision

Functions	Input Range	
sinx cosx	Deg	$0 \leq  x  < 9 \times 10^9$
	Rad	$0 \leq  x  < 157079632.7$
	Gra	$0 \leq  x  < 1 \times 10^{10}$

tan x	Deg	Same as sin x, except when $ x  = (2n-1) \times 90$ .
	Rad	Same as sin x, except when $ x  = (2n-1) \times \pi/2$ .
	Gra	Same as sin x, except when $ x  = (2n-1) \times 100$ .
$\sin^{-1}x, \cos^{-1}x$	$0 \leq  x  \leq 1$	
$\tan^{-1}x$	$0 \leq  x  \leq 9.999999999 \times 10^{99}$	
$\sinh x, \cosh x$	$0 \leq  x  \leq 230.2585092$	
$\sinh^{-1}x$	$0 \leq  x  \leq 4.999999999 \times 10^{99}$	
$\cosh^{-1}x$	$1 \leq x \leq 4.999999999 \times 10^{99}$	
$\tanh x$	$0 \leq  x  \leq 9.999999999 \times 10^{99}$	
$\tanh^{-1}x$	$0 \leq  x  \leq 9.999999999 \times 10^{-1}$	
$\log x, \ln x$	$0 < x \leq 9.999999999 \times 10^{99}$	
$10^x$	$-9.999999999 \times 10^{99} \leq x \leq 99.99999999$	
$e^x$	$-9.999999999 \times 10^{99} \leq x \leq 230.2585092$	
$\sqrt{x}$	$0 \leq x < 1 \times 10^{100}$	
$x^2$	$ x  < 1 \times 10^{50}$	
$x^{-1}$	$ x  < 1 \times 10^{100}; x \neq 0$	
$\sqrt[3]{x}$	$ x  < 1 \times 10^{100}$	
$x!$	$0 \leq x \leq 69$ ( $x$ is an integer)	
${}^n P_r$	$0 \leq n < 1 \times 10^{10}, 0 \leq r \leq n$ ( $n, r$ are integers) $1 \leq \{n!/(n-r)!\} < 1 \times 10^{100}$	
${}^n C_r$	$0 \leq n < 1 \times 10^{10}, 0 \leq r \leq n$ ( $n, r$ are integers) $1 \leq n!/r! < 1 \times 10^{100}$ or $1 \leq n!/(n-r)! < 1 \times 10^{100}$	

Pol( $x, y$ )	$ x ,  y  \leq 9.999999999 \times 10^{99}$ $\sqrt{x^2 + y^2} \leq 9.999999999 \times 10^{99}$
Rec( $r, \theta$ )	$0 \leq r \leq 9.999999999 \times 10^{99}$ $\theta$ : Same as $\sin x$
$a^\circ b'c''$	$ a , b, c < 1 \times 10^{100}$ ; $0 \leq b, c$ The display seconds value is subject to an error of $\pm 1$ at the second decimal place.
$\leftarrow$ $\circ, ''$	$ x  < 1 \times 10^{100}$ Decimal $\leftrightarrow$ Sexagesimal Conversions $0^\circ 0' 0'' \leq  x  \leq 99999999^\circ 59' 59''$
$x^y$	$x > 0$ : $-1 \times 10^{100} < y \log x < 100$ $x = 0$ : $y > 0$ $x < 0$ : $y = n, \frac{m}{2n+1}$ ( $m, n$ are integers) However: $-1 \times 10^{100} < y \log  x  < 100$
$\sqrt[x]{y}$	$y > 0$ : $x \neq 0, -1 \times 10^{100} < 1/x \log y < 100$ $y = 0$ : $x > 0$ $y < 0$ : $x = 2n+1, \frac{2n+1}{m}$ ( $m \neq 0$ ; $m, n$ are integers) However: $-1 \times 10^{100} < 1/x \log  y  < 100$
$a^{b/c}$	Total of integer, numerator, and denominator must be 10 digits or less (including separator symbol).
RanInt#( $a, b$ )	$a < b$ ; $ a ,  b  < 1 \times 10^{10}$ ; $b - a < 1 \times 10^{10}$
GCD( $a, b$ )	$ a ,  b  < 1 \times 10^{10}$ ( $a, b$ are integers)
LCM( $a, b$ )	$0 \leq a, b < 1 \times 10^{10}$ ( $a, b$ are integers)

- Precision is basically the same as that described under "Calculation Range and Precision", above.
- $x^y, \sqrt[x]{y}, \sqrt[3]{y}, x!, nPr, nCr$  type functions require consecutive internal calculation, which can cause accumulation of errors that occur with each calculation.
- Error is cumulative and tends to be large in the vicinity of a function's singular point and inflection point.
- The range for calculation results that can be displayed in  $\pi$  form when using Natural Display is  $|x| < 10^6$ . Note, however, that internal calculation

error can make it impossible to display some calculation results in  $\pi$  form. It also can cause calculation results that should be in decimal form to appear in  $\pi$  form.

## Specifications

---

### Power Requirements:

Built-in solar cell; button battery LR44 × 1

### Approximate Battery Life:

3 years (based on one hour of operation per day)

### Operating Temperature:

0°C to 40°C (32°F to 104°F)

### Dimensions:

11.1 (H) × 77 (W) × 161.5 (D) mm

$\frac{3}{8}$ " (H) × 3" (W) ×  $6\frac{3}{8}$ " (D)

### Approximate Weight:

95 g (3.4 oz) including the battery

## Verifying the Authenticity of Your Calculator

---

Use the steps below to verify that your calculator is a genuine CASIO calculator.

1. Press **MODE**.
  2. Press **0**.
    - This displays the information below.
      - Calculator ID number (24-character string)
      - QR Code for accessing the Worldwide Education Service (<https://wes.casio.com/calc/>)
  3. Access the above site.
  4. Follow the instructions on the display to verify the authenticity of your calculator.
- Press **AC** to return to the mode menu.

# Frequently Asked Questions

---

## Frequently Asked Questions

---

- **How can I perform input and display results the same way I did on a model that does not have Natural Textbook Format?**  
→ Perform the following key operation: **SHIFT** **MODE** (SETUP) **2** (LineIO). See "Configuring the Calculator Setup" for more information.
  
- **How can I change a fraction form result to decimal form?**  
**How can I change a fraction form result produced by a division operation to decimal form?**  
→ See "Toggling Calculation Results" for the procedure.
  
- **What is the difference between Ans memory, PreAns memory, independent memory, and variable memory?**  
→ Each of these types of memory acts like "containers" for temporary storage of a single value.  
**Ans Memory:**  
Stores the result of the last calculation performed. Use this memory to carry the result of one calculation on to the next.  
**PreAns Memory:**  
Stores the result of calculation before the last one. PreAns memory can be used only in the COMP Mode.  
**Independent Memory:**  
Use this memory to totalize the results of multiple calculations.  
**Variables:**  
This memory is helpful when you need to use the same value multiple times in one or more calculations.
  
- **What is the key operation to take me from the STAT Mode or TABLE Mode to a mode where I can perform arithmetic calculations?**  
→ Press **MODE** **1** (COMP).
  
- **How can I return the calculator to its initial default settings?**  
→ Perform the following key operation: **SHIFT** **9** (CLR) **1** (Setup) **≡** (Yes).
  
- **When I execute a function calculation, why do I get a calculation result that is completely different from older CASIO calculator models?**  
→ With a Natural Textbook Display model, the argument of a function that uses parentheses must be followed by a closing parenthesis. Failing to

press  $\text{)}\text{}$  after the argument to close the parentheses may cause unwanted values or expressions to be included as part of the argument.

---

Example:  $(\sin 30) + 15$  (Angle Unit: Deg)

Older (S-V.P.A.M.) Model:  $\text{sin} 30 \text{+} 15 \text{=}$  15.5

Natural Textbook Display Model:

(LineIO)  $\text{sin} 30 \text{)} \text{+} 15 \text{=}$  15.5

Failure to press  $\text{)}\text{}$  here as shown below will result in calculation of  $\sin 45$ .

$\text{sin} 30 \text{+} 15 \text{=}$  0.7071067812

---



**CASIO®**